

Precision phenomenology with heavy-flavour jets at the LHC

Rene Poncelet

based on 2011.01011, 2205.11879, 2212.00467 and 2308.02285
and preliminary Les Houches studies



THE HENRYK NIEWODNICZAŃSKI
INSTITUTE OF NUCLEAR PHYSICS
POLISH ACADEMY OF SCIENCES

Presented research received
funding from:

LEVERHULME
TRUST



Outline

- Phenomenological motivation
 - Vector bosons + flavoured jets
 - Infrared safety/sensitivity
- NNLO QCD Phenomenology with $W+c$ -jets
- Flavoured (anti- k_T) jet algorithms
 - (Tests of IR-safety)

What are the fundamental building blocks of matter?

Scattering experiments

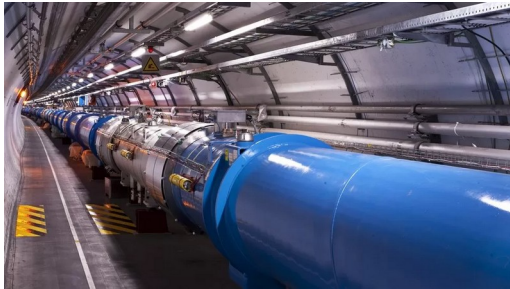

Credit: CERN

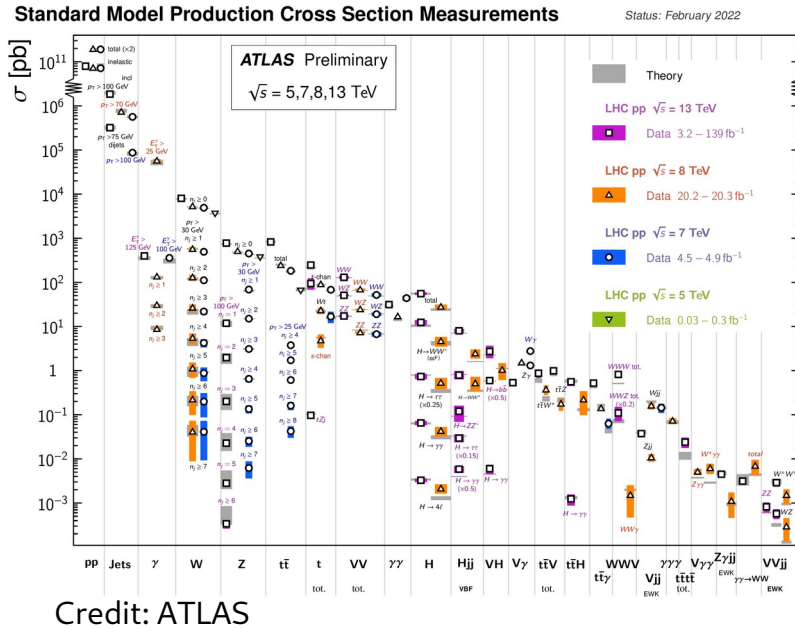

Theory/Model

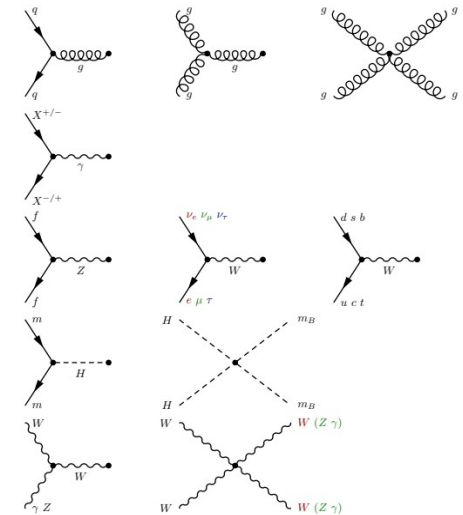

Credit: Jack Lindon, CERN

Looking into **more exclusive observables** (“flavoured jets”) with **more precision** (“higher order corrections”).

W + charm jet

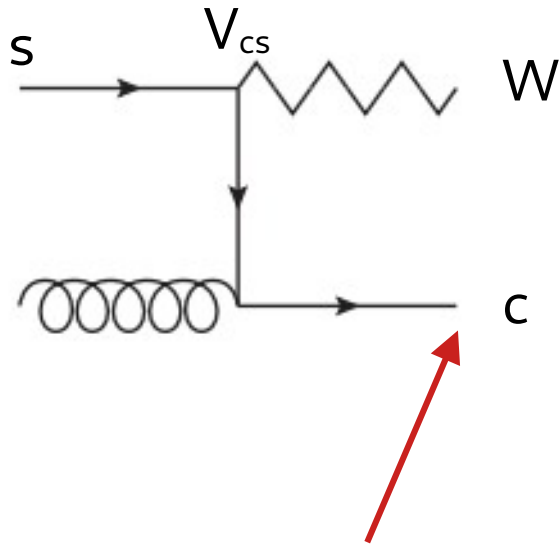

Tagging of charm jet
to increase sensitivity
to strange quark PDF

gluon PDF:

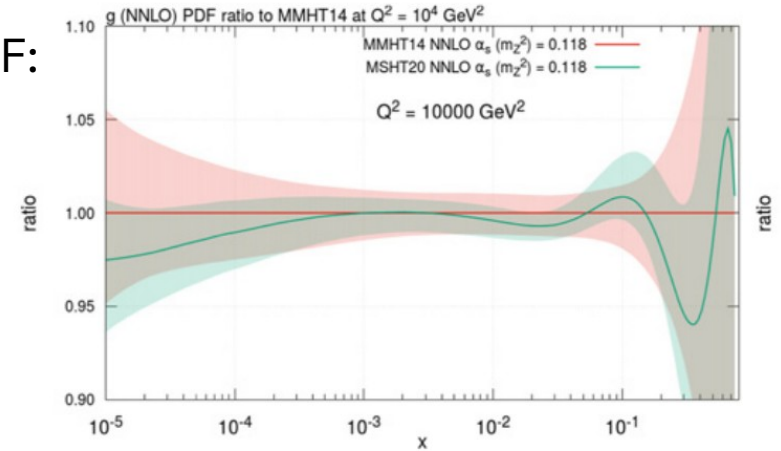

s+s PDF:

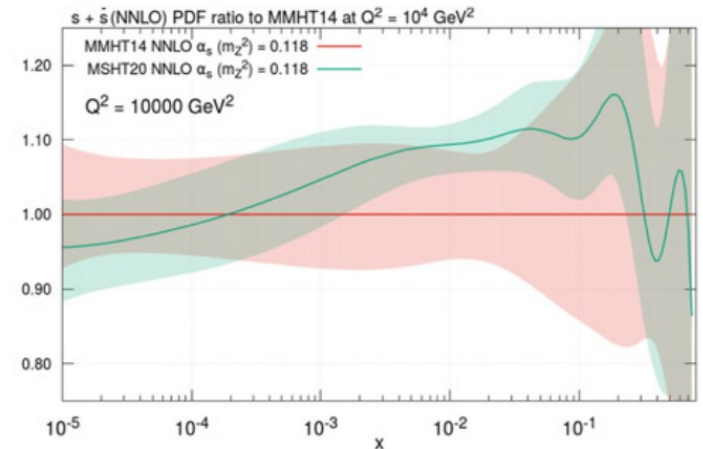

PDF4LHC22 [2203.05506]

W + charm jet

Could solve long-standing puzzle:
Strange – anti – strange asymmetry

- pQCD: Three loop SM prediction $q \rightarrow q' \neq q \rightarrow \bar{q}'$ small effect $\langle x(s-\bar{s}) \rangle \sim 10^{-4}$
- Size of non-perturbative effect unknown

7 TeV analysis favours $s \neq \bar{s}$

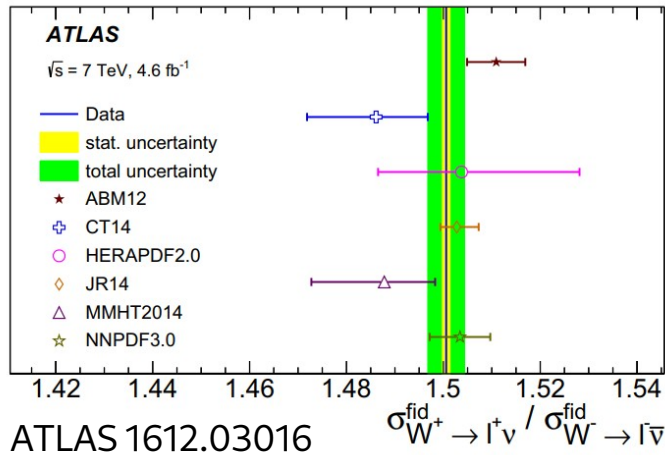

13 TeV analysis favours $s = \bar{s}$

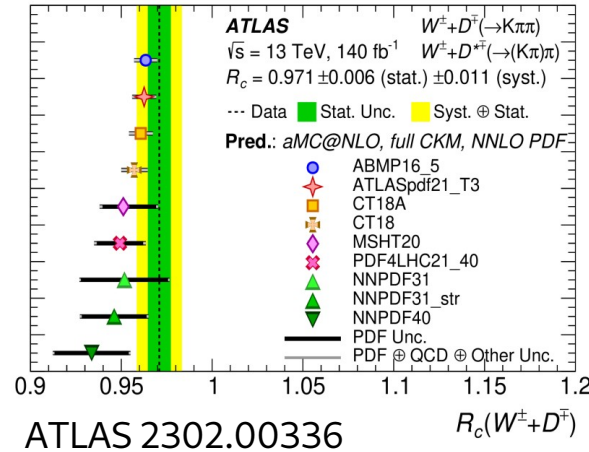

All at NLO QCD
 higher order
 corrections needed
 to fit properly the
 PDF

Z + charm jet

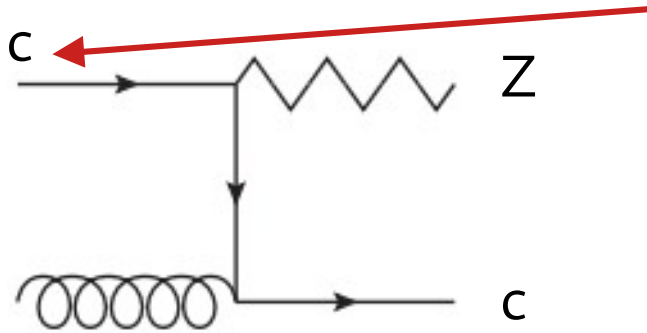

Similar to W+charm but for charm PDF

Intrinsic charm component?
Clarification needs
→ higher order corrections
→ charm jet definition

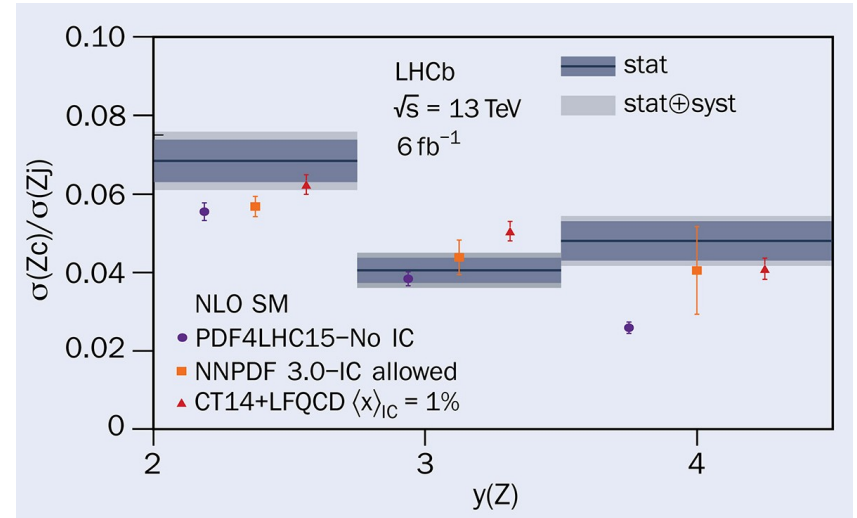

CERN/LHCb 2109.08084

Flavoured jets are everywhere

- Flavoured jets as signature
 - Top-quarks
 - Vector+heavy flavour: $pp \rightarrow W/Z/A + c/b$
 - Higgs \rightarrow charm, Higgs \rightarrow bottom
 - New physics searches
- This talk: V + heavy-flavour
 - Benchmark for flavour tagging
 - IR safety/sensitivity
 - (Heavy-quark evolution: fragmentation and hadronisation)



Rely on our capability to
 \rightarrow identify flavoured jets
 \rightarrow and interpret them

Heavy flavour production

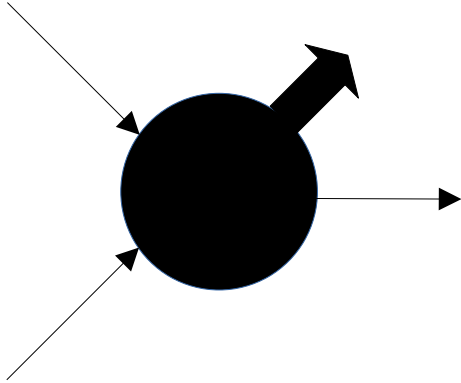

Setup for this talk:
Production of a massive quark(s)
with high transverse momentum: $p_T \gg m$

Partonic jet evolution

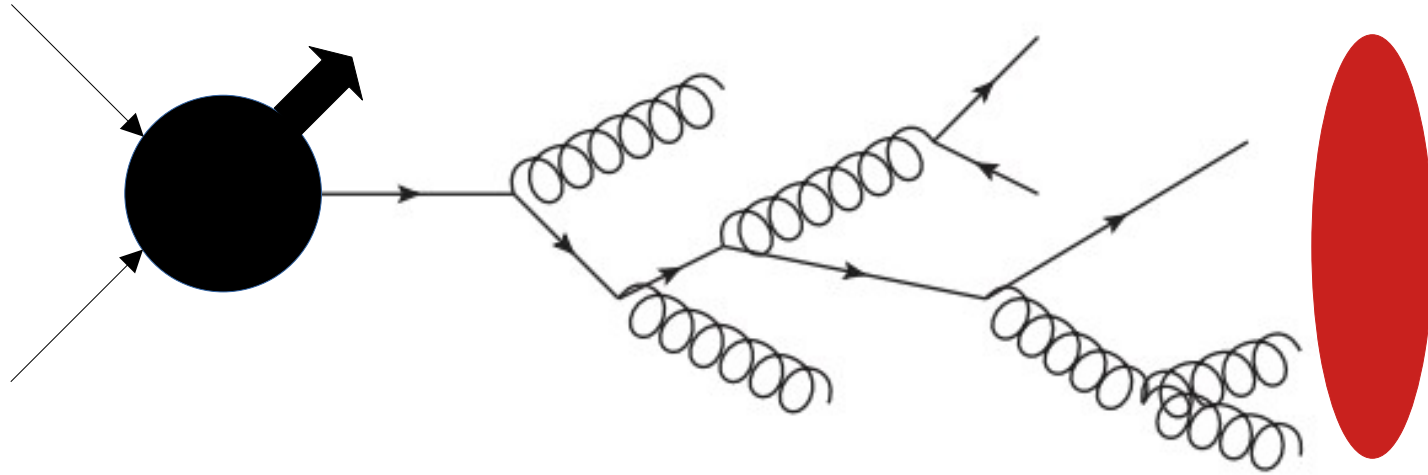

Partonic jet evolution

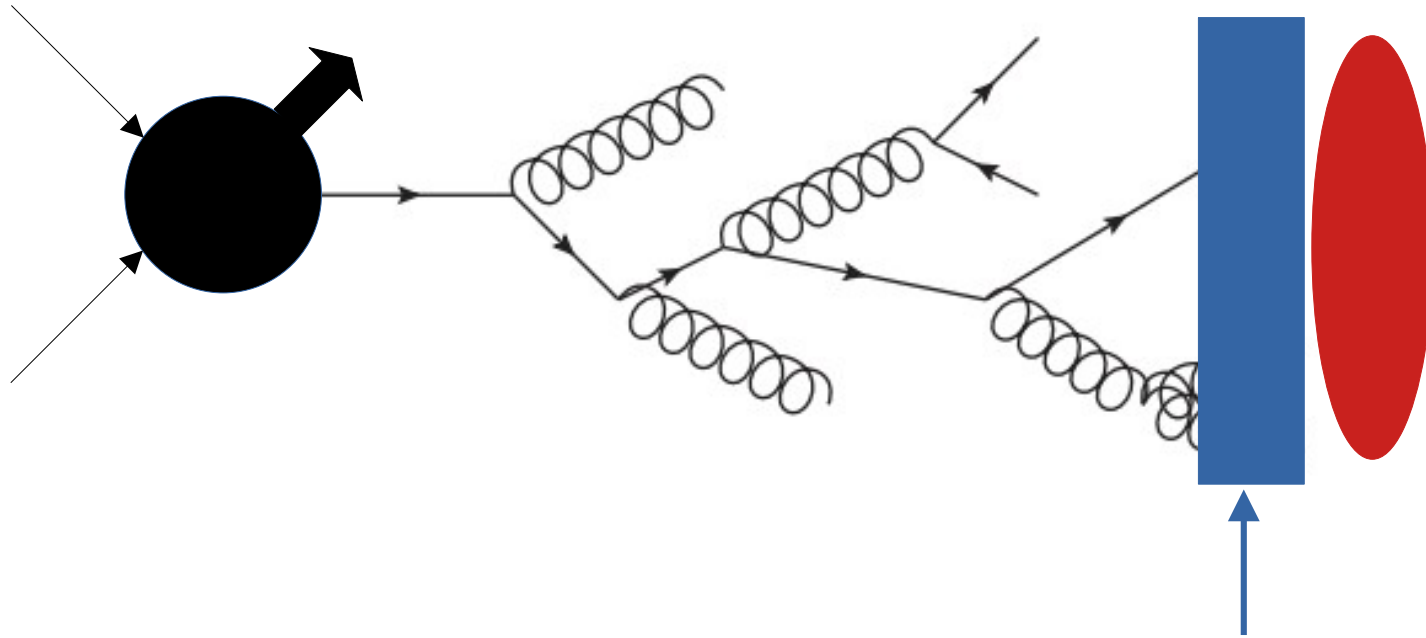

- Fragmentation/Hadronisation
- Partonic jet flavour: Quark-Hadron Duality
- Heavy B/D – hadron's long life time: experiment signature (displaced vertices) → distinguishable from "light" jets

Partonic jet evolution

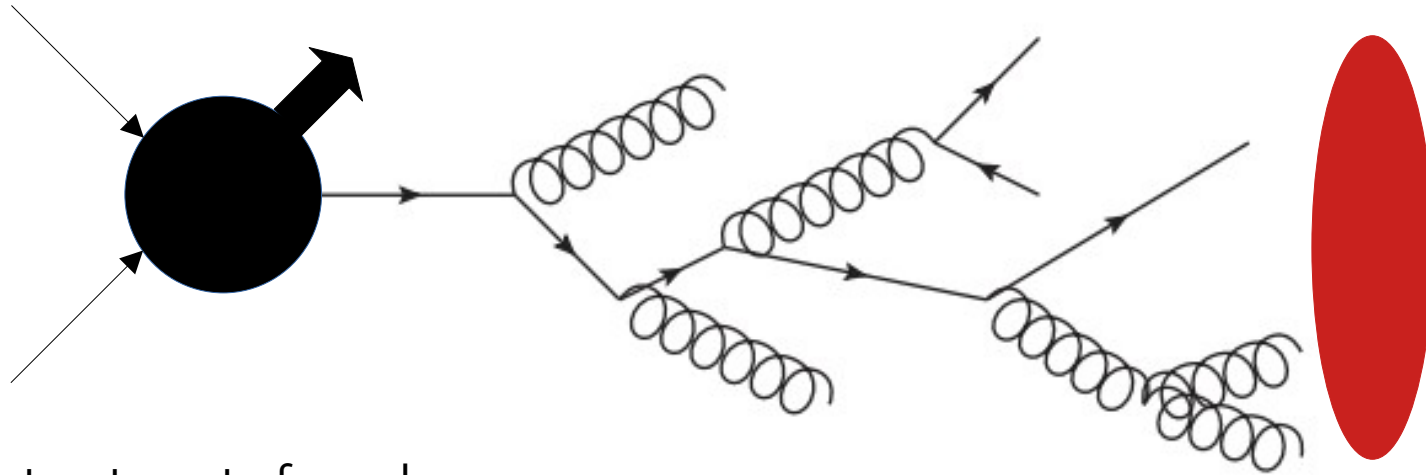

Massive treatment of quark

- Mass acts as IR regulator \rightarrow no IR divergences from collinear splitting
- Price to pay: $\log(p_T/m)$, how to treat PDFs (high Q^2 process due to V-boson)?
 - \rightarrow Resummation for reliable predictions
 - \rightarrow Parton-showers (at low accuracy)
- **But** Higher order calculations more difficult } NLO+PS
 - \rightarrow some applications (like PDF fits) need **fixed order** pQCD at higher orders

Partonic jet evolution

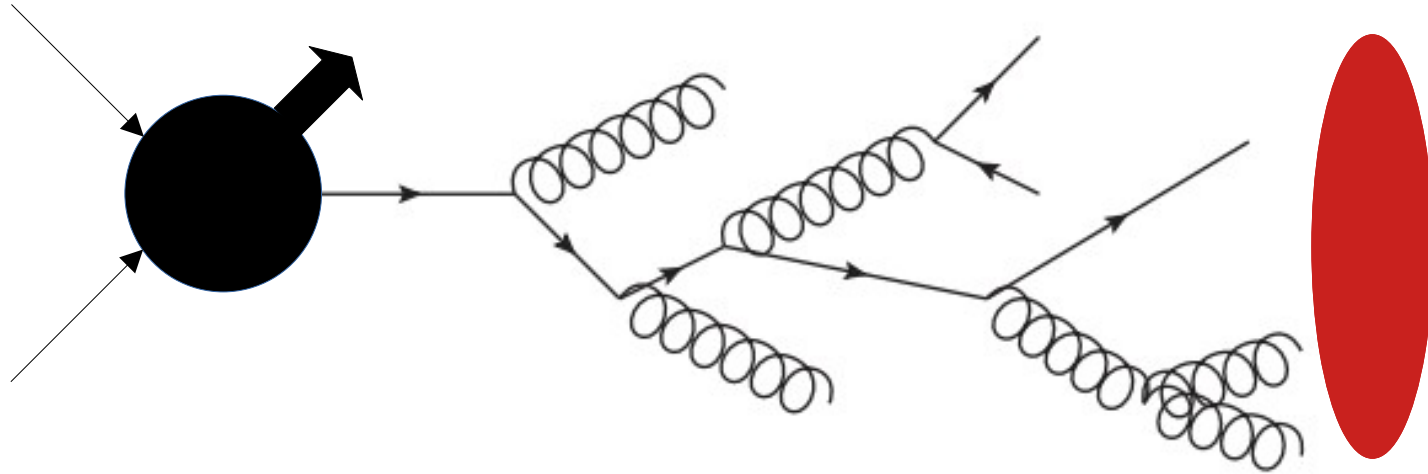

High transverse momentum \rightarrow massless quarks

- Collinear (mass) divergences absorbed by renormalisation
- Consistent treatment with PDFs (high $Q^2 \rightarrow$ c/b quarks in DGLAP)
- Bonus: higher order calculations easier \rightarrow NNLO QCD de-facto standard
- **BUT**: IR-safety more demanding due to collinear and soft flavoured particles

Hadronic cross section in collinear factorization – NNLO QCD

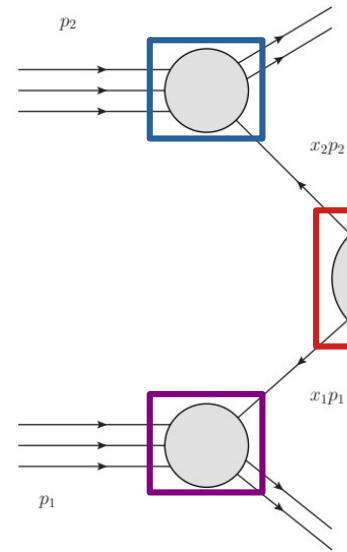

Hadronic X-section:
$$\sigma_{h_1 h_2 \rightarrow X} = \sum_{ij} \int_0^1 \int_0^1 dx_1 dx_2 \underbrace{\phi_{i/h_1}(x_1, \mu_F^2)}_{\text{Parton distribution functions}} \underbrace{\phi_{j/h_2}(x_2, \mu_F^2)}_{\text{Parton distribution functions}} \underbrace{\hat{\sigma}_{ij \rightarrow X}(\alpha_s(\mu_R^2), \mu_R^2, \mu_F^2)}_{\text{Partononic cross section}}$$

Parton distribution functions

Perturbative expansion of partonic cross section:

$$\hat{\sigma}_{ab \rightarrow X} = \hat{\sigma}_{ab \rightarrow X}^{(0)} + \hat{\sigma}_{ab \rightarrow X}^{(1)} + \hat{\sigma}_{ab \rightarrow X}^{(2)} + \mathcal{O}(\alpha_s^3)$$

The NLO bit:
$$\hat{\sigma}_{ab}^{(1)} = \hat{\sigma}_{ab}^R + \hat{\sigma}_{ab}^V + \hat{\sigma}_{ab}^C$$

Real radiation

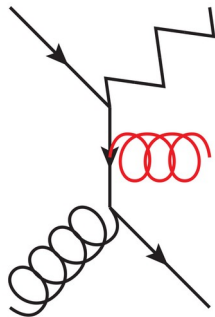

Virtual correction

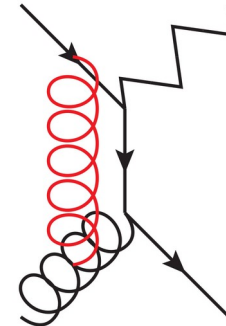

Hadronic cross section in collinear factorization – NNLO QCD

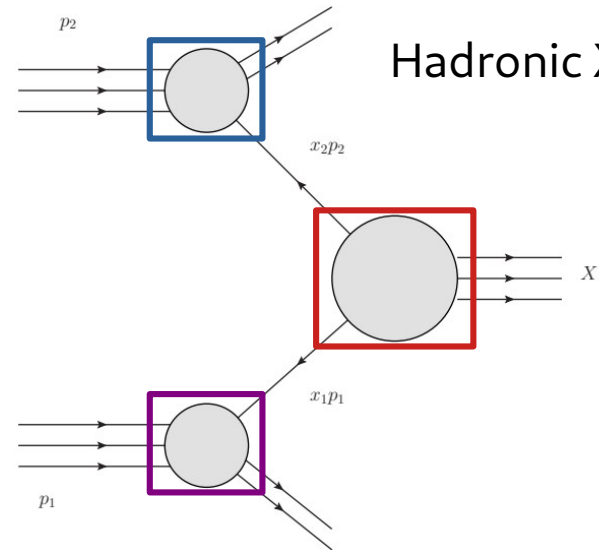

Hadronic X-section:
$$\sigma_{h_1 h_2 \rightarrow X} = \sum_{ij} \int_0^1 \int_0^1 dx_1 dx_2 \underbrace{\phi_{i/h_1}(x_1, \mu_F^2)}_{\text{Parton distribution functions}} \underbrace{\phi_{j/h_2}(x_2, \mu_F^2)}_{\text{Parton distribution functions}} \underbrace{\hat{\sigma}_{ij \rightarrow X}(\alpha_s(\mu_R^2), \mu_R^2, \mu_F^2)}_{\text{Partonic cross section}}$$

Parton distribution functions

Perturbative expansion of partonic cross section:

$$\hat{\sigma}_{ab \rightarrow X} = \hat{\sigma}_{ab \rightarrow X}^{(0)} + \hat{\sigma}_{ab \rightarrow X}^{(1)} + \hat{\sigma}_{ab \rightarrow X}^{(2)} + \mathcal{O}(\alpha_s^3)$$

The NNLO bit:
$$\hat{\sigma}_{ab}^{(2)} = \hat{\sigma}_{ab}^{\text{RR}} + \hat{\sigma}_{ab}^{\text{RV}} + \hat{\sigma}_{ab}^{\text{VV}} + \hat{\sigma}_{ab}^{\text{C2}} + \hat{\sigma}_{ab}^{\text{C1}}$$

Double real radiation

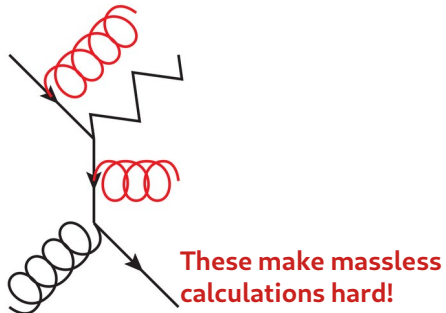

Real/Virtual correction

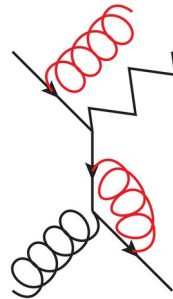

Double virtual corrections

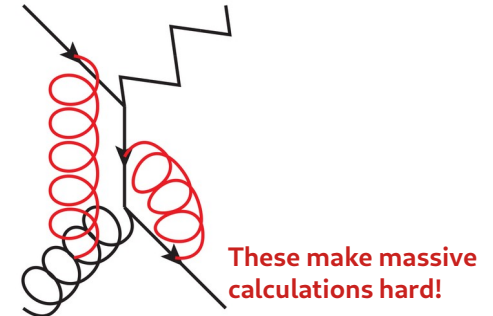

Hadronic cross section in collinear factorization – NNLO QCD

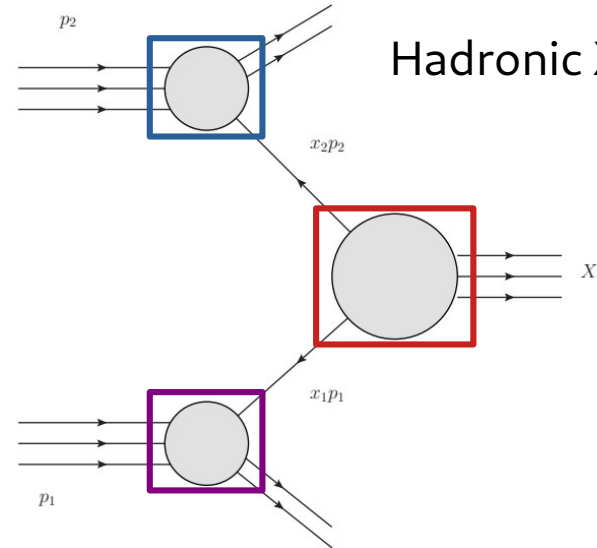

Hadronic X-section:
$$\sigma_{h_1 h_2 \rightarrow X} = \sum_{ij} \int_0^1 \int_0^1 dx_1 dx_2 \underbrace{\phi_{i/h_1}(x_1, \mu_F^2)}_{\text{Parton distribution functions}} \underbrace{\phi_{j/h_2}(x_2, \mu_F^2)}_{\text{Parton distribution functions}} \underbrace{\hat{\sigma}_{ij \rightarrow X}(\alpha_s(\mu_R^2), \mu_R^2, \mu_F^2)}_{\text{Partonic cross section}}$$

Parton distribution functions

Perturbative expansion of partonic cross section:

$$\hat{\sigma}_{ab \rightarrow X} = \hat{\sigma}_{ab \rightarrow X}^{(0)} + \hat{\sigma}_{ab \rightarrow X}^{(1)} + \hat{\sigma}_{ab \rightarrow X}^{(2)} + \mathcal{O}(\alpha_s^3)$$

The NNLO bit:
$$\hat{\sigma}_{ab}^{(2)} = \hat{\sigma}_{ab}^{\text{RR}} + \hat{\sigma}_{ab}^{\text{RV}} + \hat{\sigma}_{ab}^{\text{VV}} + \hat{\sigma}_{ab}^{\text{C2}} + \hat{\sigma}_{ab}^{\text{C1}}$$

Calculations performed with sector-improved residue subtraction scheme
1408.2500 & 1907.12911

IR safety issues starting from NLO QCD

Massless QCD: Cancellation of IR divergences between real and virtual corrections

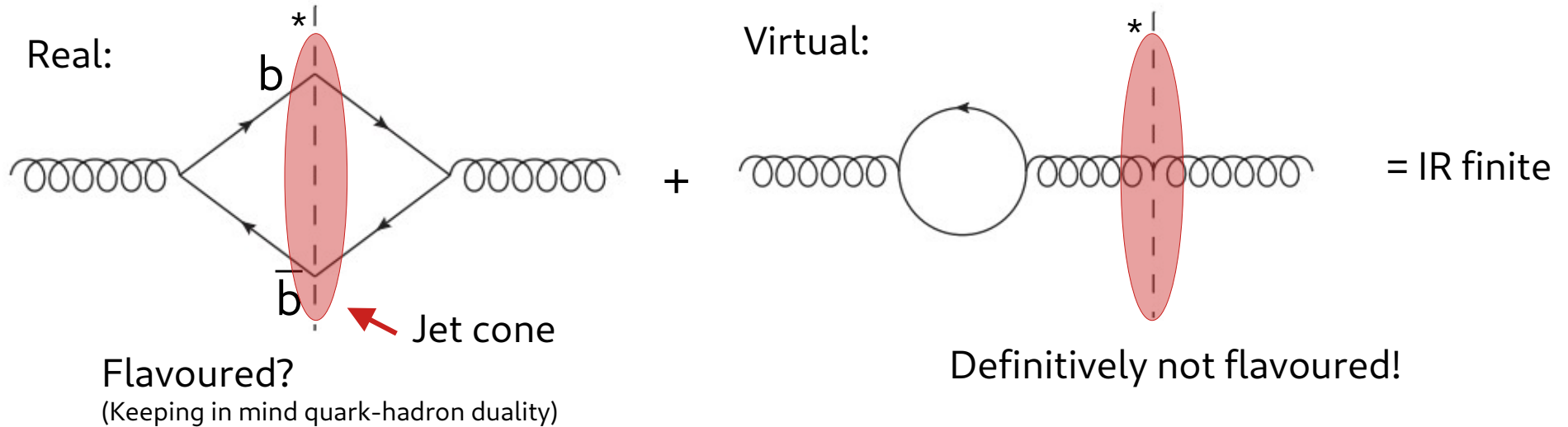

$b \bar{b}$ has to count as a gluon/light jet!

*: cut symbolises the "measured" final state

IR safety issues starting from NNLO QCD

Double soft limit of quark pairs

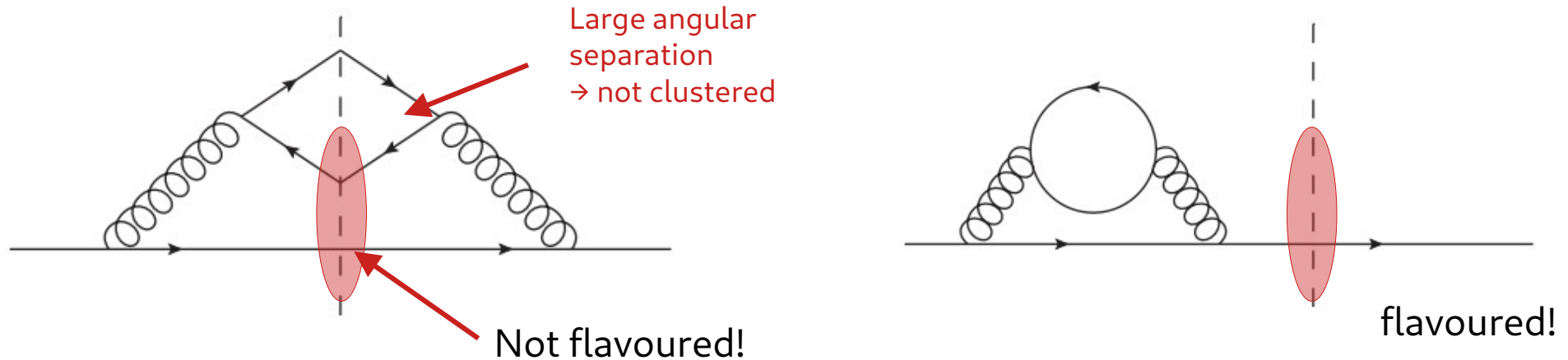

- These double soft splitting need to be captured
- **Requires to interleave kinematics and flavour information!**

Solution: Modified jet algorithms

→ Implies correlated treatment of kinematics and flavour information

Standard kT algorithm:

Pair distance:

$$d_{ij} = \min(k_{T,i}^2, k_{T,j}^2) R_{ij}^2$$

$$R_{ij}^2 = (\Delta\phi_{ij}^2 + \Delta\eta_{ij}^2) / R^2$$

“Beam” distance for determination condition:

$$d_i = k_{T,i}^2$$

Flavour kT algorithm:

Infrared safe definition of jet flavor,
Banfi, Salam, Zanderighi hep-ph/0601139

Pair distance:

$$d_{ij} = R_{ij}^2 \begin{cases} \max(k_{T,i}, k_{T,j})^\alpha \min(k_{T,i}, k_{T,j})^{2-\alpha} & \text{softer of } i, j \text{ is flavoured} \\ \min(k_{T,i}, k_{T,j})^\alpha & \text{else} \end{cases}$$

Beam distance:

$$d_{i,B} = \begin{cases} \max(k_{T,i}, k_{T,B}(y_i))^\alpha \min(k_{T,i}, k_{T,B}(y_i))^{2-\alpha} & i \text{ is flavoured} \\ \min(k_{T,i}, k_{T,B}(y_i))^\alpha & \text{else} \end{cases}$$

$$d_B(\eta) = \sum_i k_{T,i} (\theta(\eta_i - \eta) + \theta(\eta - \eta_i)) e^{\eta_i - \eta}$$

$$d_{\bar{B}}(\eta) = \sum_i k_{T,i} (\theta(\eta - \eta_i) + \theta(\eta_i - \eta)) e^{\eta - \eta_i}$$

Approaches to heavy flavour

Massive

- FO more complicated
- Resummation of logs \rightarrow PS
- Flavour-scheme/PDFs?

Massless

- Easier
- IR safety of jets?
- Mass/Threshold effects at intermediate p_T ?

FONLL

- Matching between Massive/massless
- Useful for PDF fits?

Fragmentation

- Perturbative fragmentation \rightarrow Resummation of mass effects
- Hadronic observables

Approaches to heavy flavour

Massive

- FO more complicated
- Resummation of logs \rightarrow PS
- Flavour-scheme/PDFs?

Massless

- Easier
- IR safety of jets?
- Mass/Threshold effects at intermediate p_T ?

How does this compare to experiment?

FONLL

- Matching between Massive/massless
- Useful for PDF fits?

Fragmentation

- Perturbative fragmentation \rightarrow Resummation of mass effects
- Hadronic observables

Experimental b/c-tagging

Credit: Arnaud Duperrin (DIS23 talk)

Secondary vertex (SV) tagging

- Long-life time
→ several mm flight
- Looking for the decay products of B-hadron decays forming SV

Challenges

- Fake SV from fragmentation
- Material interactions
- Pile-up

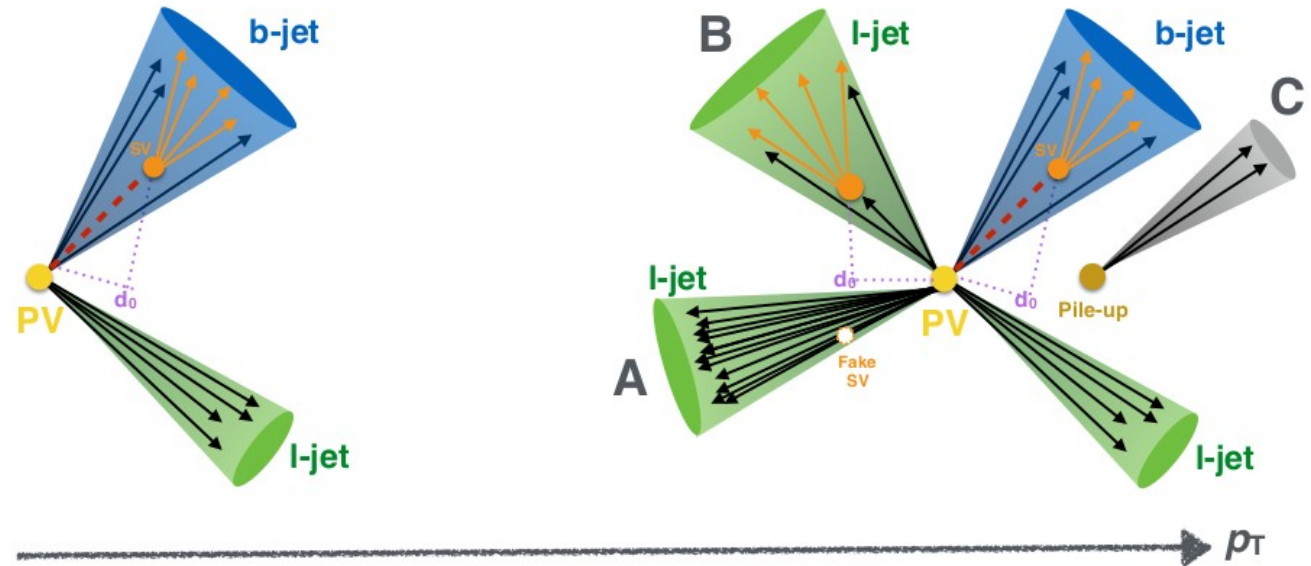

Experimental b/c-tagging with NN

Using NN to perform b-tagging

- Many Run II/III analysis use already NN based taggers
- For example ATLAS: DL1
 - uses precomputed low-level infos
- Next generation will directly use hit, track and jet information
 - further performance boost

The truth level information comes from MC simulations

Credit: Arnaud Duperrin (DIS23 talk)

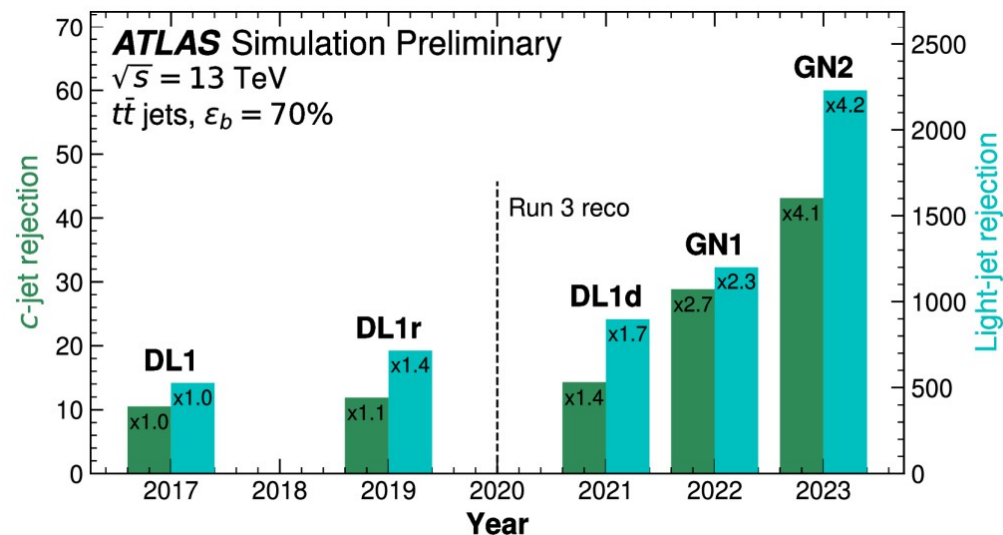
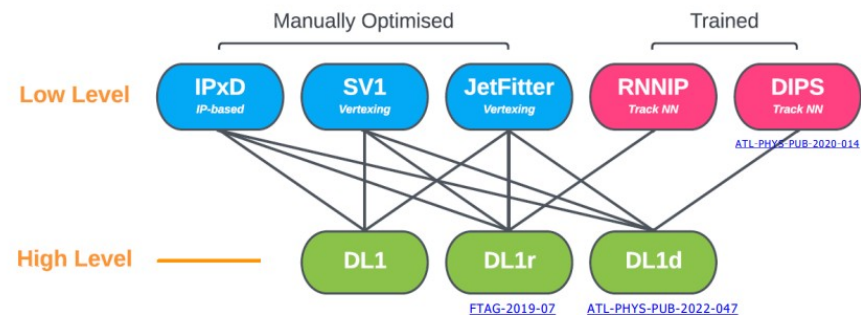

Ghost tagging

A jet is defined as flavoured if:

- 1) it contains at least one B/D hadron
FO: IR-unsafe because of $g \rightarrow b \bar{b}$ splitting
- 2) within $dR < R$ of jet axis
FO: IR-unsafe because soft wide angle emission
- 3) with $pT > pT_{\text{cut}}$
FO: collinear unsafe $b \rightarrow b g$ splitting
(okay in fragmentation approach)



“Truth” labelling used in Monte Carlo samples, used to train the NN

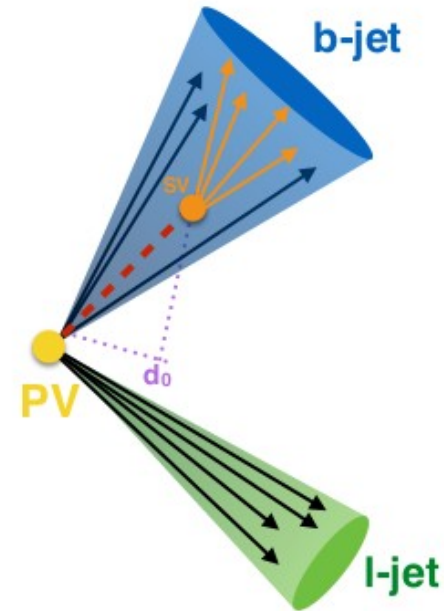

Technically okay for PS+hadronisation models
BUT

Unsatisfactory from theory point of view
(trading IR safety with sensitivity)

Issues for precision phenomenology

- The flavoured jet algorithms require detailed flavour information
→ flavour algorithms difficult to implement experimentally
Limited by detector-resolution & efficiencies!
- For now: comparisons to higher order QCD partonic computations require corrections for the differences in tagging procedures! → Unfolding!
 - 1) $g \rightarrow b \bar{b}$ splitting if both b 's hadronise to B-hadrons
(this is different to $b \bar{b} = g$ @ fixed order)
 - 2) Hadronisation/non-perturbative models
- Unfolding corrections can be sizeable $O(5-10\%)$

NNLO QCD $W+c$ -jet

W+charm production

A detailed investigation of W+c-jet at the LHC,
Czakon, Mitov, Pellen, Poncelet 2212.00467

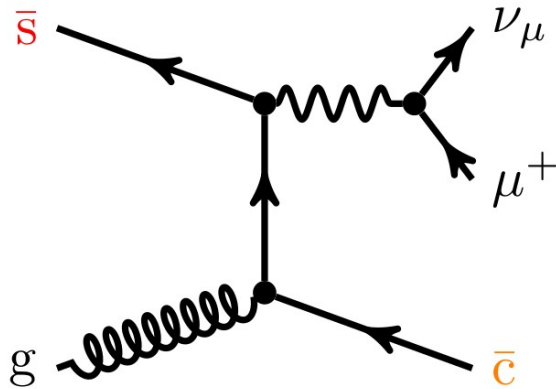

Simple phase space:

$$p_{T,\ell} > 30 \text{ GeV}, \quad |\eta_\ell| < 2.5$$

$$p_{T,j_c} > 20 \text{ GeV}, \quad |\eta_{j_c}| < 2.5$$

Various effects studied:

- NNLO QCD corrections
- Electroweak corrections
- Off-diagonal CKM matrix
- PDF sensitivity
- Tagging requirements
- **Flavoured jet-algorithms**

All ~5% effects

Perturbative corrections

Flavour-kT, inclusive c-jet requirements

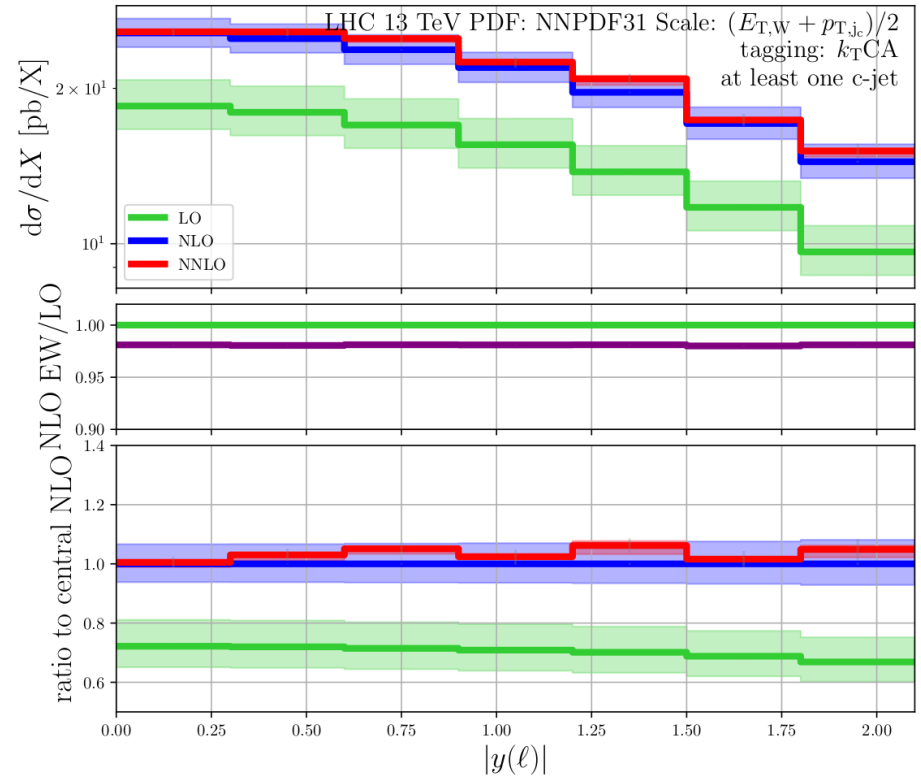
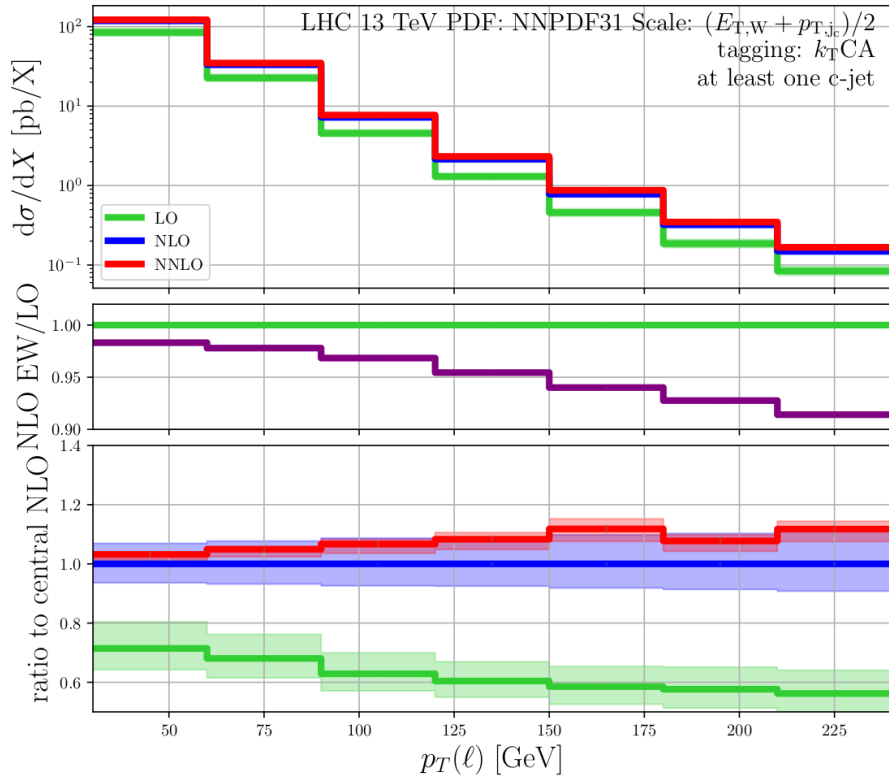

Off-diagonal CKM

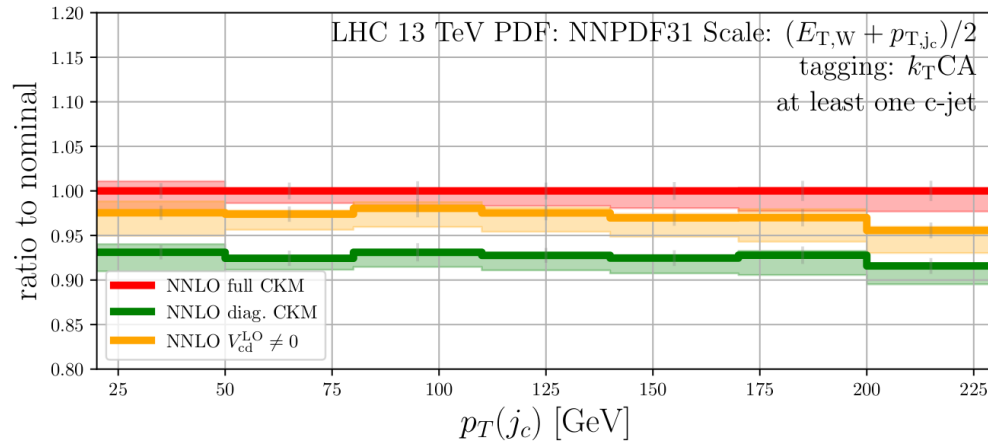
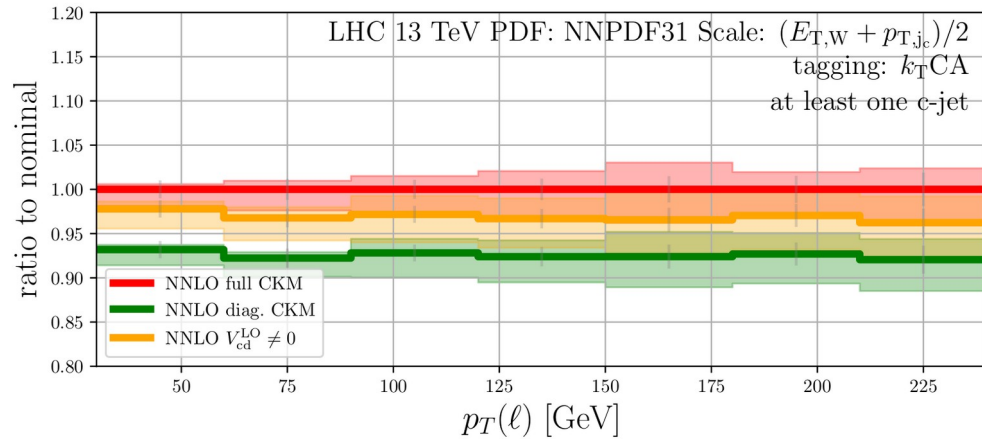

- Full CKM effects through NNLO QCD
- **Sizeable with respect NNLO corrections!**
- LO V_{cd} captures most of the full CKM

PDF dependence

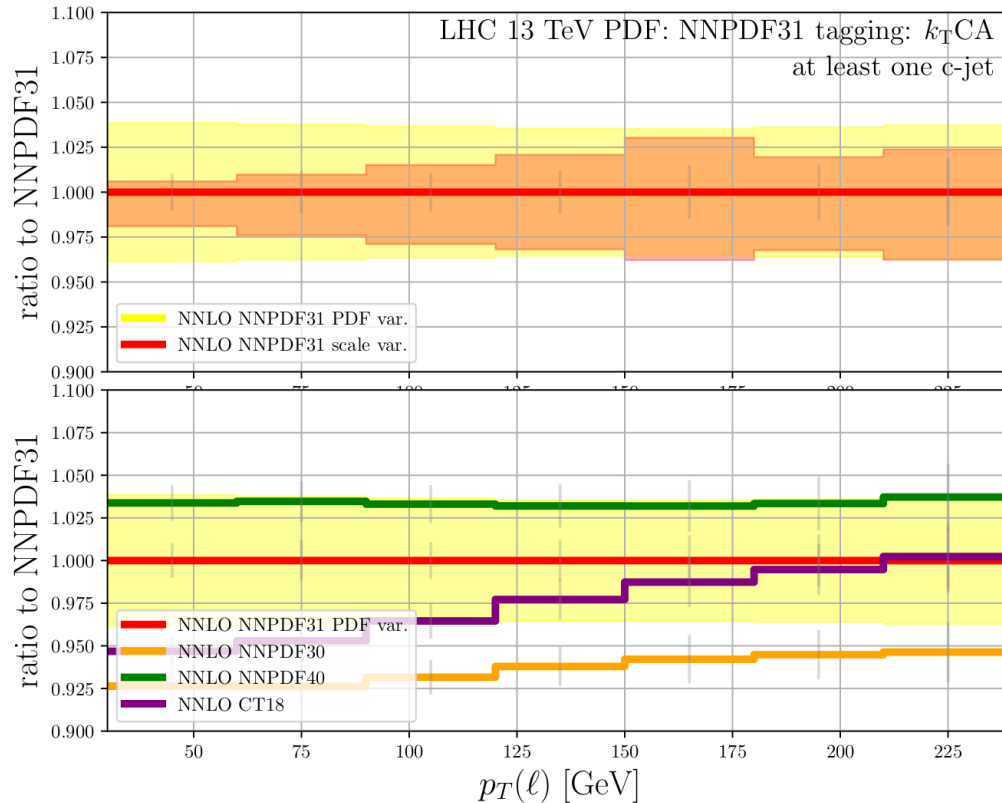

- PDF uncertainty: ~5%
- PDF model variations: ~5-8%
→ different s-quark PDF treatment:
 - NNPDF asymmetric
 - CT18 symmetric
- Uncertainty > NNLO QCD uncertainty

Different tagging requirements

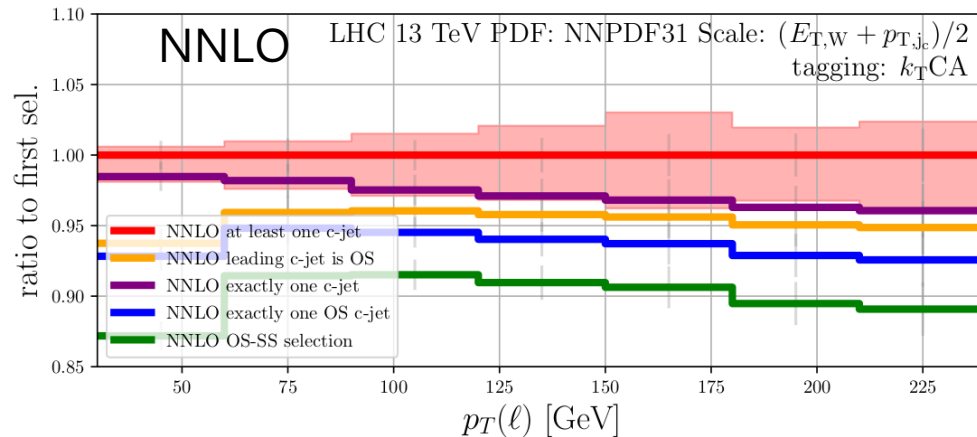
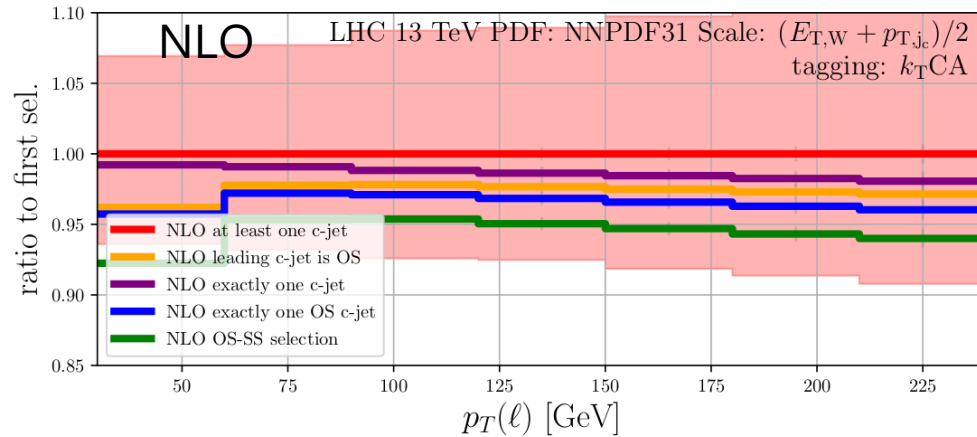

Different tagging requirements

- The leading c-jet (based on its transverse momentum) is of OS type, no requirement on c-jet multiplicity,
- One and only one c-jet is required, no requirement on c-jet charge,
- One and only one c-jet of OS type,
- One and only one c-jet of SS type,
- OS-SS ("OS minus SS") cross section.

W+c-jet with flavour kT at NNLO QCD

NNLO QCD predictions for W+c-jet production at the LHC,
Czakon, Mitov, Pellen, Poncelet 2011.01011

NNLO QCD 7 TeV results:

- Full NNLO corrections for Vcs contribution
- Off-diagonal CKM only LO QCD
- Comparison flv. kT results vs. ATLAS

Measurement of the production of a W boson in association with a charm quark in pp collisions at $\sqrt{s} = 7$ TeV with the ATLAS detector, 1402.6263

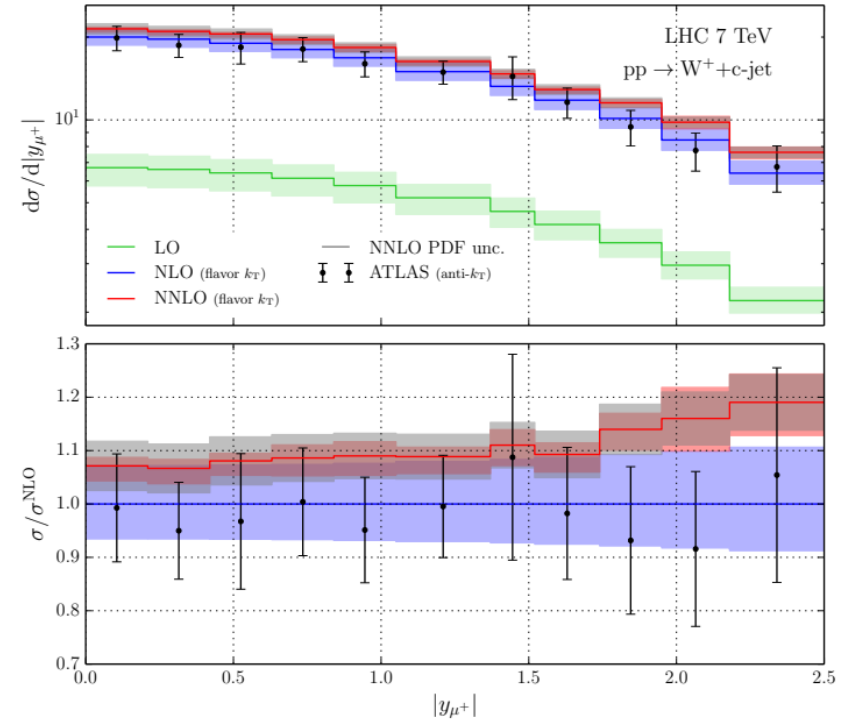

Caveat: flavour-kT vs. anti-kT

Flavour anti-kT?

The standard algorithm for the LHC is the anti-kT:

→ nice geometric properties

→ less sensitive to soft physics

Towards Jetography
Salam 0906.1833

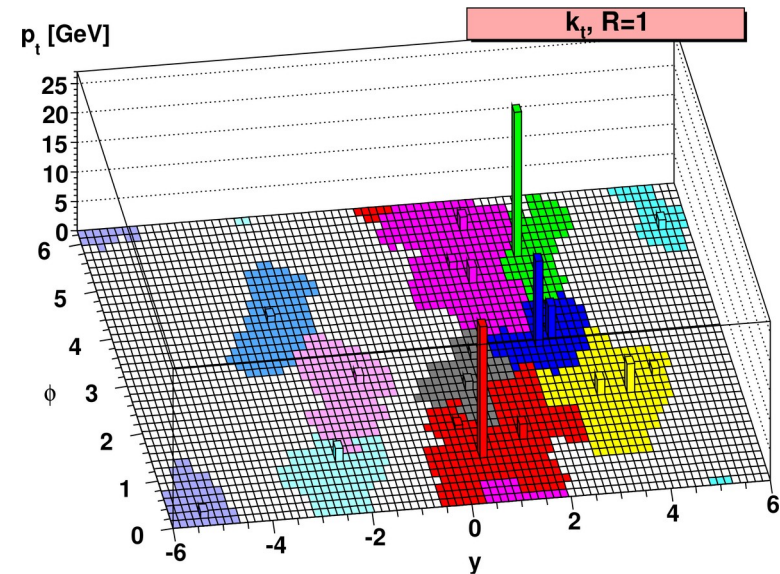
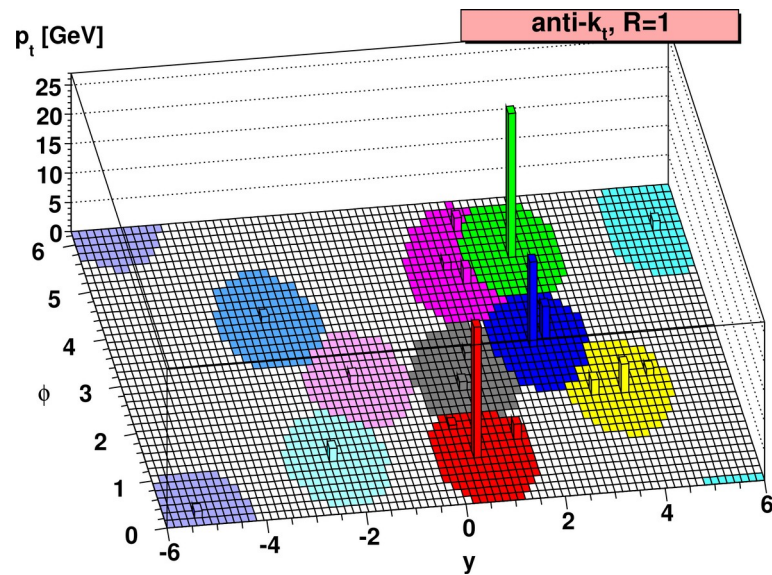

New proposals for flavour-safe anti-kT jets

- Flavour with Soft-drop **Practical Jet Flavour Through NNLO**
Caletti, Larkoski, Marzani, Reichelt 2205.01109 SDF
- Flavour anti-kT **Infrared-safe flavoured anti-kT jets,**
Czakon, Mitov, Poncelet 2205.11879 CMP
- Fragmentation approach **A Fragmentation Approach to Jet Flavor**
Caletti, Larkoski, Marzani, Reichelt 2205.01117
B-hadron production in NNLO QCD: application to LHC ttbar events with leptonic decays,
Czakon, Generet, Mitov and Poncelet, 2102.08267
- Flavour dressing → standard anti-kT + flavour assignment GHS
QCD-aware partonic jet clustering for truth-jet flavour labelling
Buckley, Pollard 1507.00508
A dress of flavour to suit any jet
Gauld, Huss, Stagnitto 2208.11138
- Interleaved flavour neutralisation
Flavoured jets with exact anti-kT kinematics and tests of infrared and collinear safety
Caola, Grabarczyk, Hutt, Salam, Scyboz, Thaler 2306.07314 IFN
- TBC...

Flavour anti-kT

Infrared-safe flavoured anti-kT jets,
Czakon, Mitov, Poncelet 2205.11879

Anti-kT: $d_{ij} = \min(k_{T,i}^{-2}, k_{T,j}^{-2}) R_{ij}^2$ $d_i = k_{T,i}^{-2}$

Proposed modification:

A **soft** term designed to modify the distance of flavoured pairs.

$$d_{ij}^{(F)} = d_{ij} \begin{cases} \mathcal{S}_{ij} & \text{i,j is flavoured pair} \\ 1 & \text{else} \end{cases}$$

A scale to define "soft"
→ Can be any hard scale

$$\mathcal{S}_{ij} \equiv 1 - \theta (1 - \kappa_{ij}) \cos\left(\frac{\pi}{2} \kappa_{ij}\right) \quad \text{with} \quad \kappa_{ij} \equiv \frac{1}{a} \frac{k_{T,i}^2 + k_{T,j}^2}{2k_{T,\text{max}}^2}$$

Allow systematic variations

Variant:
2306.07314

$$\mathcal{S}_{ij} \rightarrow \bar{\mathcal{S}}_{ij} = \mathcal{S}_{ij} \frac{\Omega_{ij}^2}{\Delta R_{ij}^2} \quad \Omega_{ik}^2 \equiv 2 \left[\frac{1}{\omega^2} (\cosh(\omega \Delta y_{ik}) - 1) - (\cos \Delta \phi_{ik} - 1) \right]$$

W+charm - jet algorithm dependence

Exactly one c-jet requirement (OS+SS):

- Comparison of parameters a:
 - small dependence < 2%
- Comparison to flv-kT:
 - small dependence @ NNLO < 2%

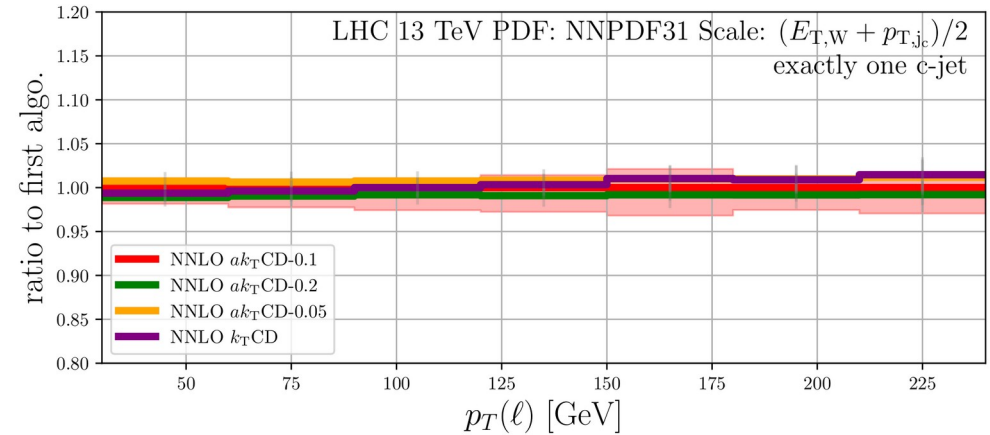

ONLY large effect in SS contribution

- Exactly one c-jet of SS type:
 - Larger dependence ~15%
 - (roughly size of NNLO scale band)
- BUT: SS contribution ~2-5%
- => OS ~0.2-0.5% dependence

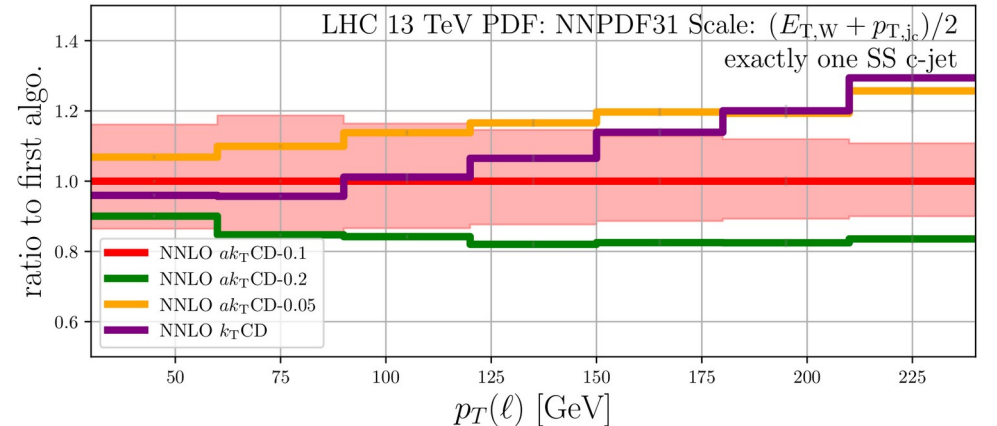

Comparison to CMS data

Measurement of the production cross section for a W boson in association with a charm quark in proton-proton collisions at $\sqrt{s} = 13$ TeV
 CMS 2308.02285

Similar phase space:

$$p_T^l > 35 \text{ GeV}, |\eta^l| < 2.4, p_T^{c \text{ jet}} > 30 \text{ GeV}$$

$$|\eta^{c \text{ jet}}| < 2.4, \Delta R(\text{jet}, l) > 0.4$$

Measurement of OS – SS cross-section unfolded to parton-level (anti-kT algorithm)

→ hadronisation and fragmentation corr. ~ 10%

+ anti-kT → flv. Anti-kT correction on fixed-order

Not ideal but a full flv. Anti-kT unfolding was not feasible at that time...

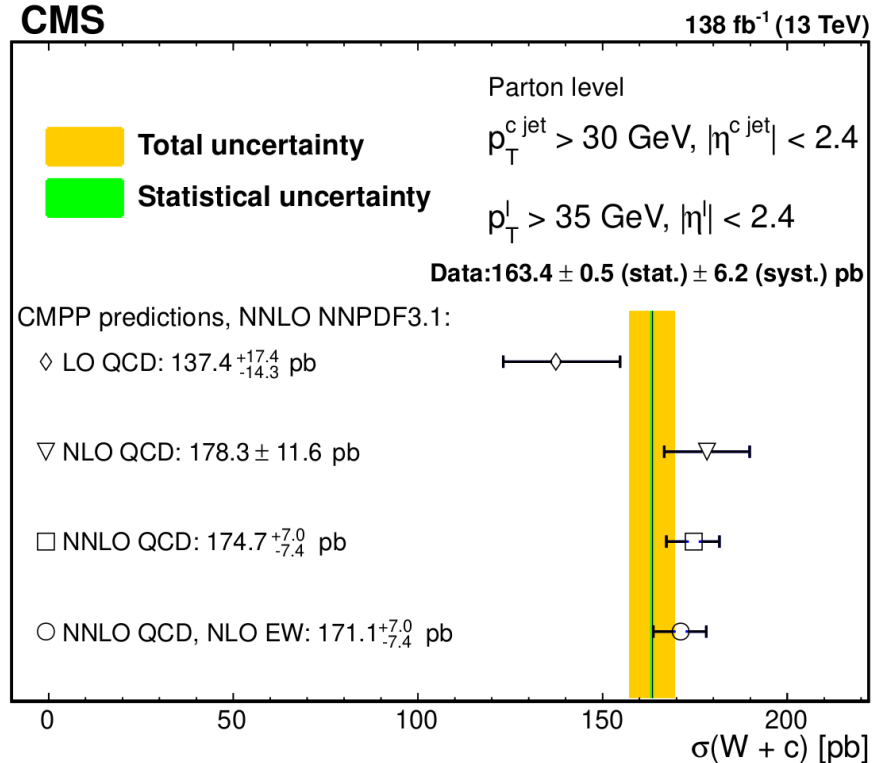

Unfolding corrections

NLO+PS (fl. anti-kT) / NLO+PS (anti-kT)

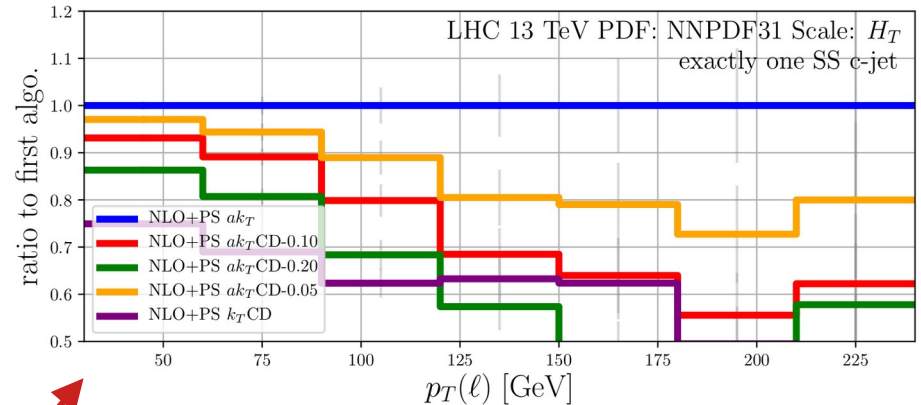
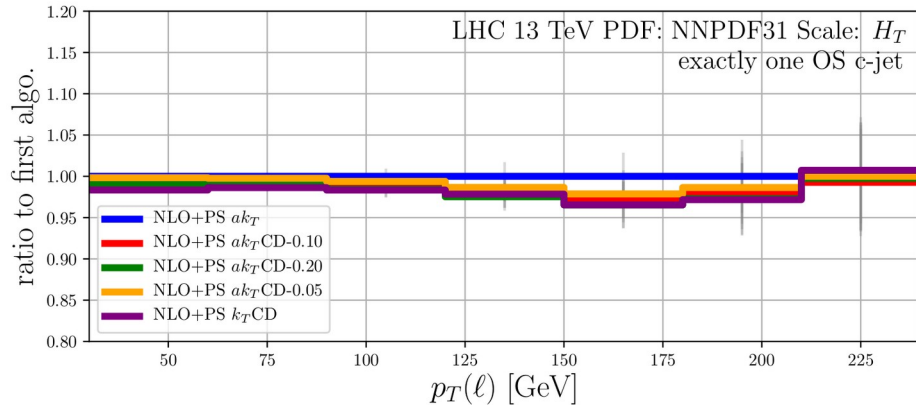

SS ~2-5% of OS
→ OS – SS unfolding corrections < 2%

Comparison to CMS data

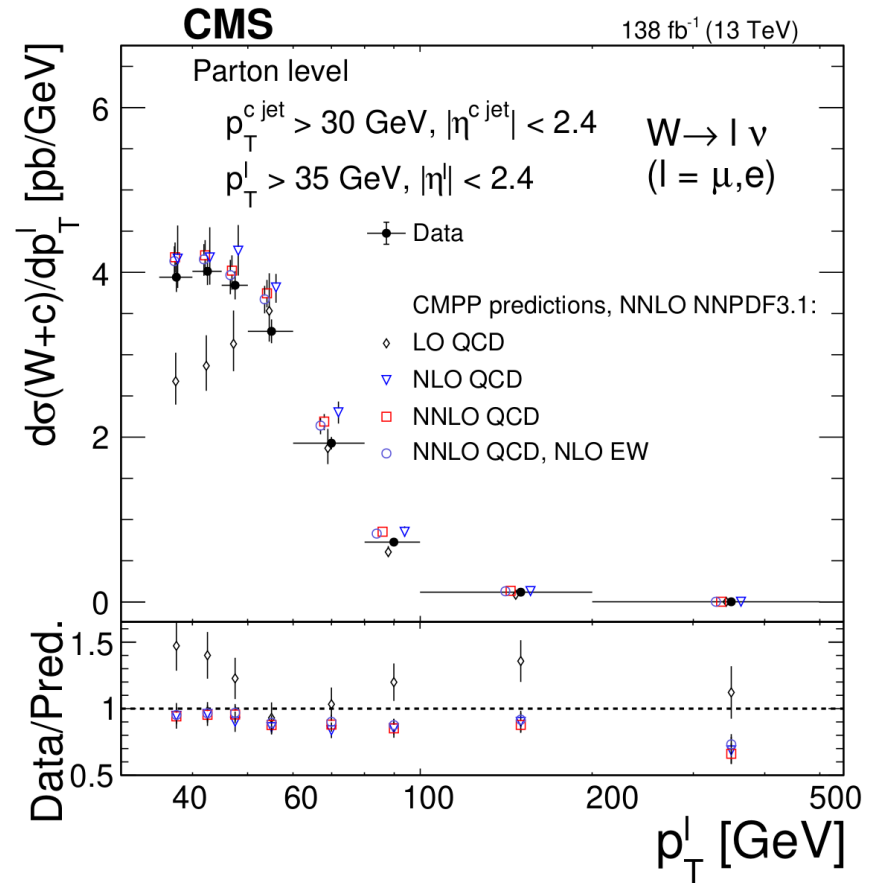
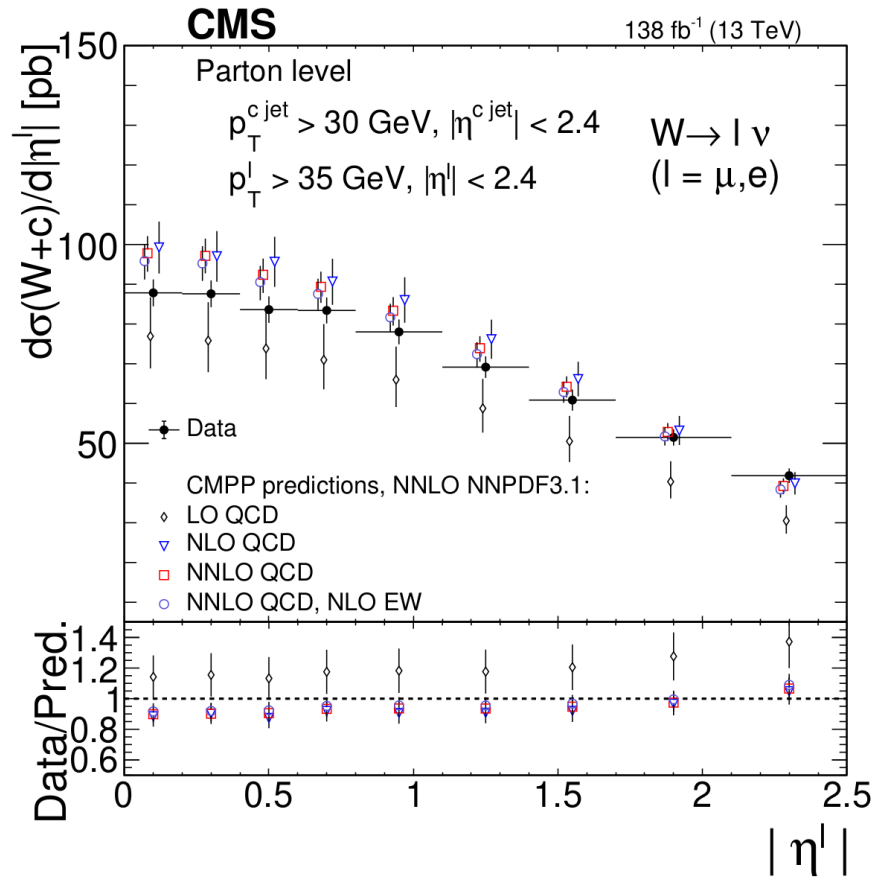

Comparison of flavoured jet algorithms

Comparisons

Les Houches 23 workshop (aka FlavourFest :))

- CMPΩ: Flavour anti-kT (with fixed \mathcal{S}_{ij})
- SDF: Flavour with Soft-drop (only IR-safe up to α_s^2 corrections)
- GHS: Flavour dressing \rightarrow standard anti-kT + flavour assignment
- IFN: Interleaved flavour neutralisation

Implementation in
FastJet package

Benchmark process: Z+b-jet following CMS analysis 1611.06507

Comparison with parton showers

HERWIG LO PS

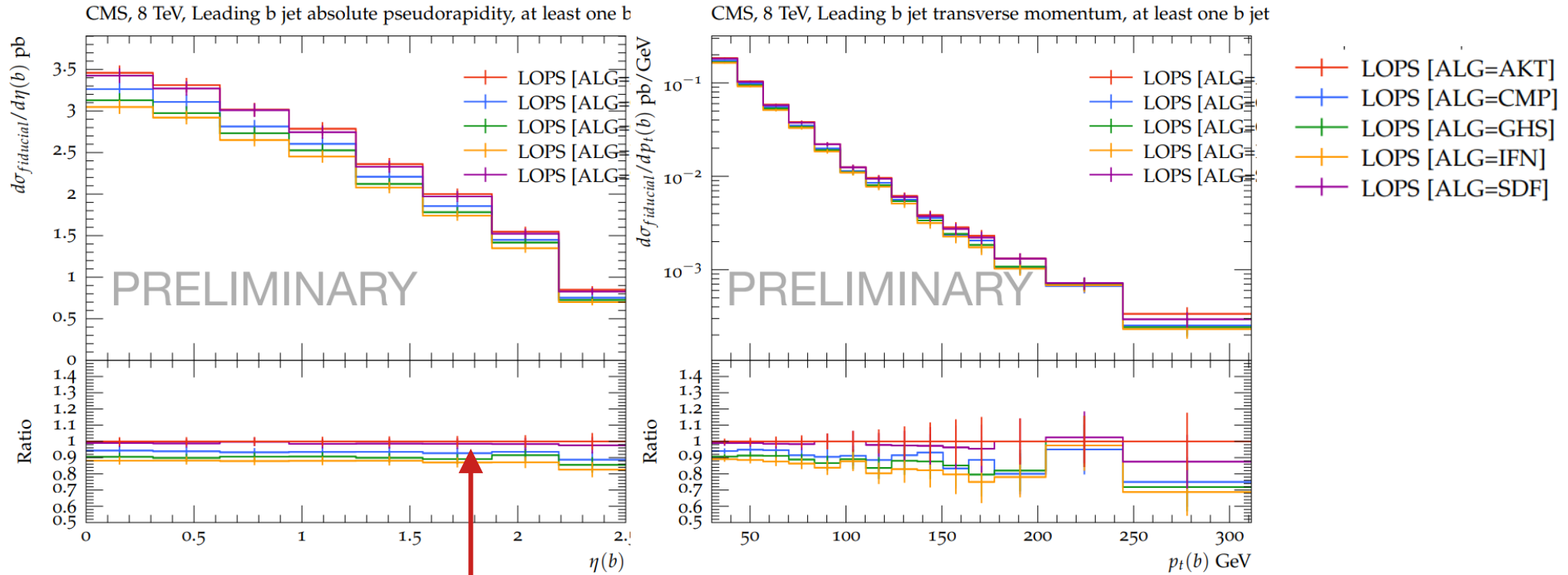

SDF ~ anti-kT → consequence of IR unsafety at higher orders?

NNLO QCD comparisons

Calculations performed with sector-improved residue subtraction scheme
1408.2500 & 1907.12911

Les Houches Jet Flavour WG

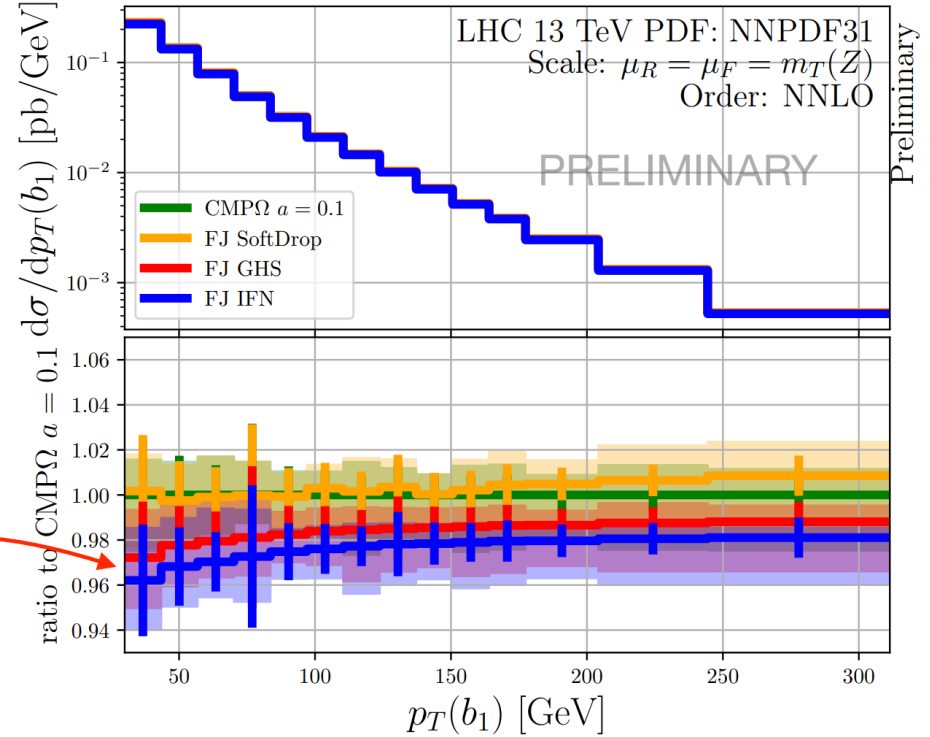
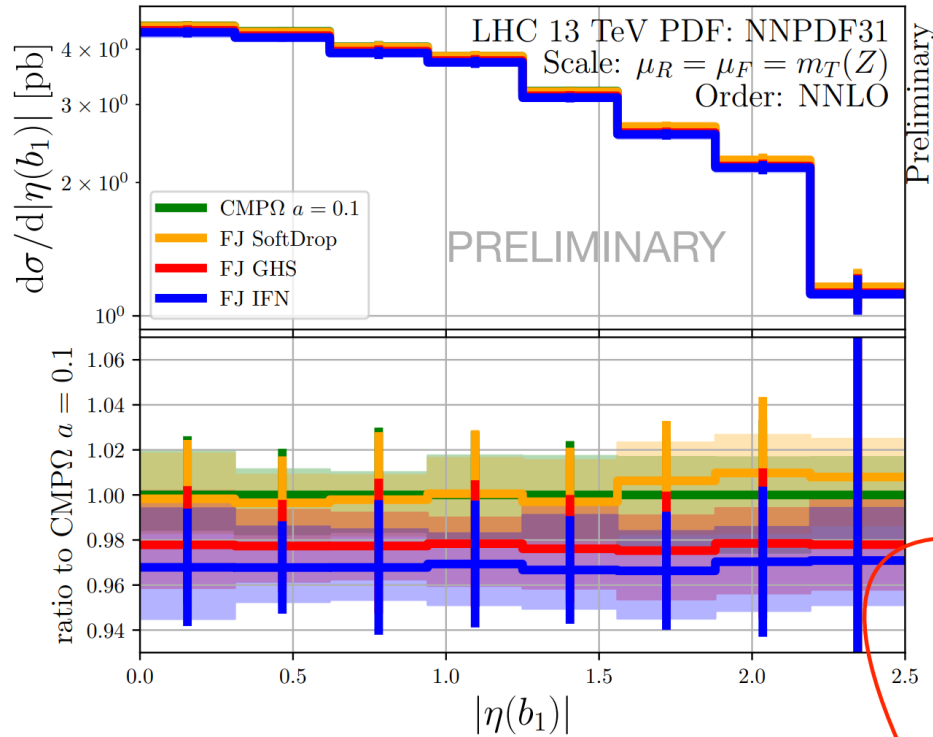

interesting shape difference at low p_T : it deserves further investigation!

Tests of IR safety

Tests of IR safety

- Rate of bad-identified jet-flavour as a function of IR sensitive variable
- Parton-shower to model many emissions

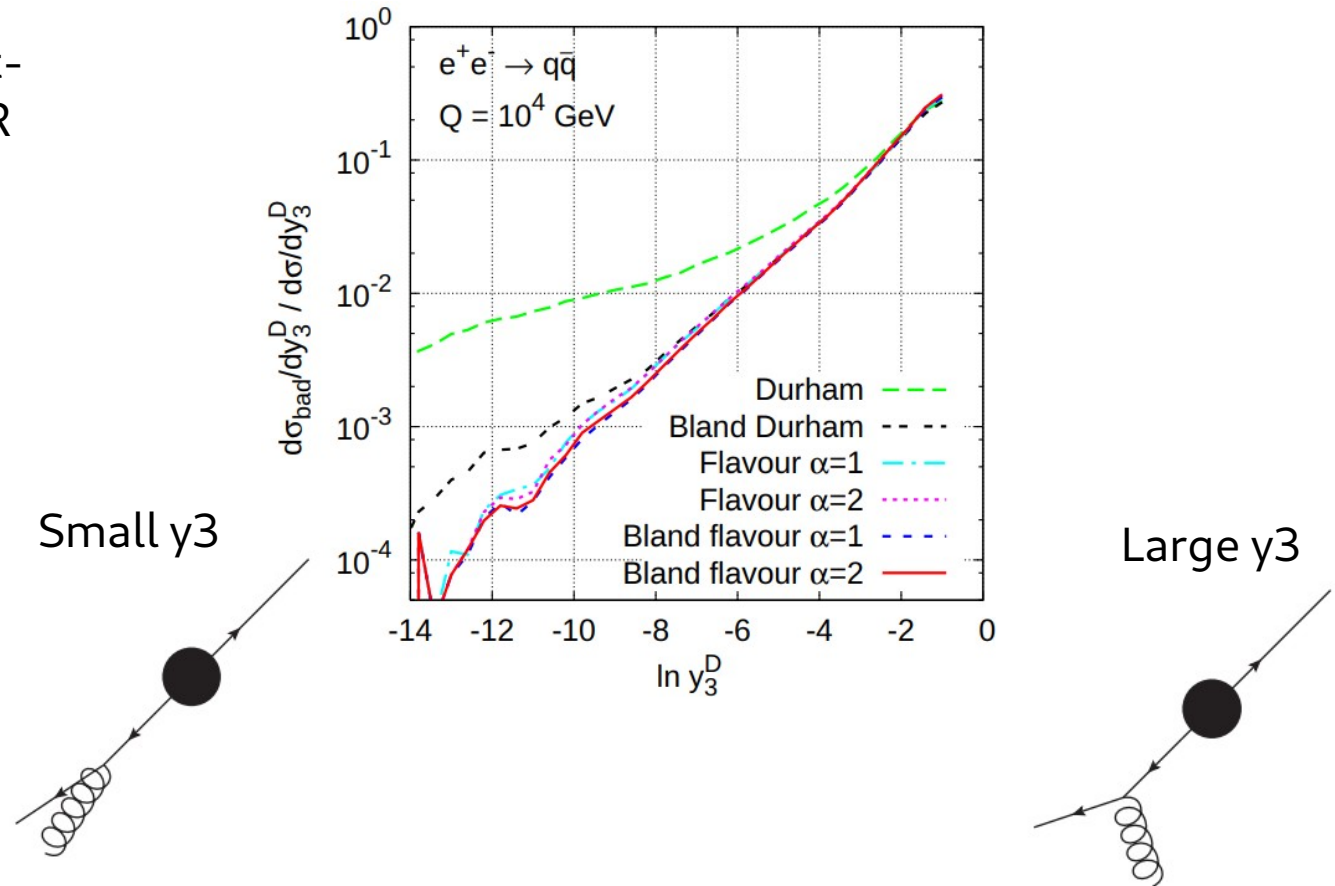

Tests of IR safety with parton showers

- In the di-jet limit the flavour needs to correspond to tree level flavours
- misidentification rate needs to vanish in di-jet back-to-back limit
- IR sensitive observable 2-jettiness

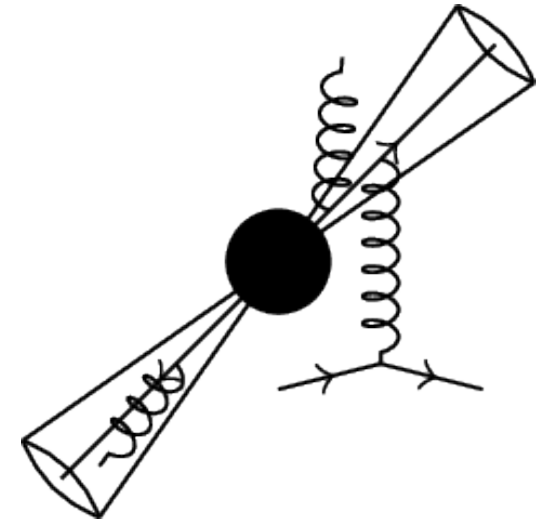
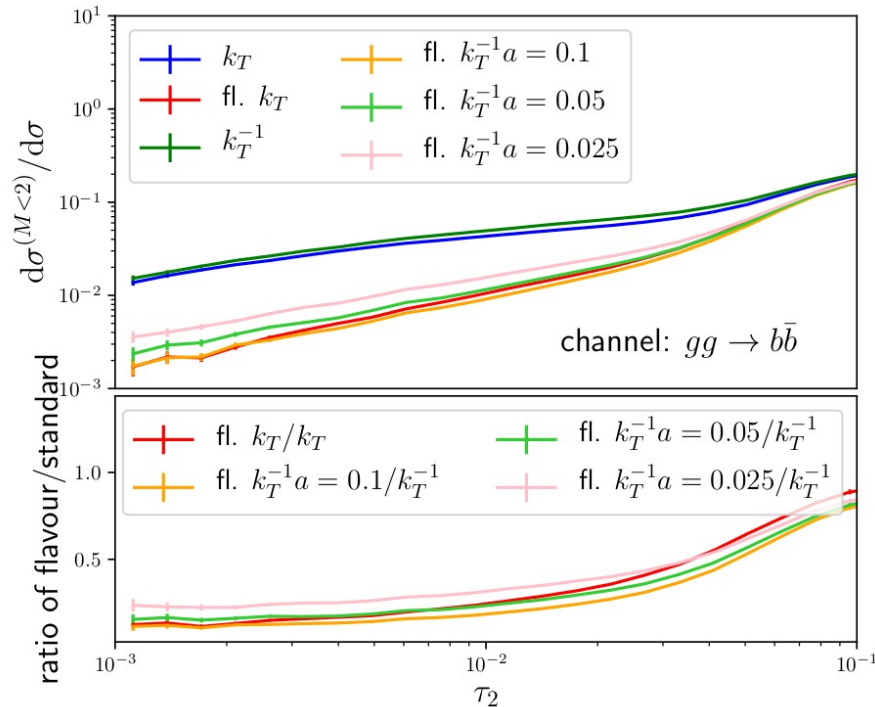

Tests of IR safety with NNLO FO computations

IR sensitivity of jet cross sections on (technical)
IR regulating parameter x

In the limit $x_{\text{cut}} \rightarrow 0$:

IR safe jet flavour \rightarrow no dependence on x_{cut}

IR non-safe jet flavour \rightarrow logarithmic divergent

$$d\sigma \ni d\Phi_{n+2} \left(\text{Diagram 1} \right) F_{n+2} + \dots + d\tilde{\Phi}_{n+2} \mathcal{S}_2 \left(\text{Diagram 2} \right) F_n \theta(x - x_{\text{cut}})$$

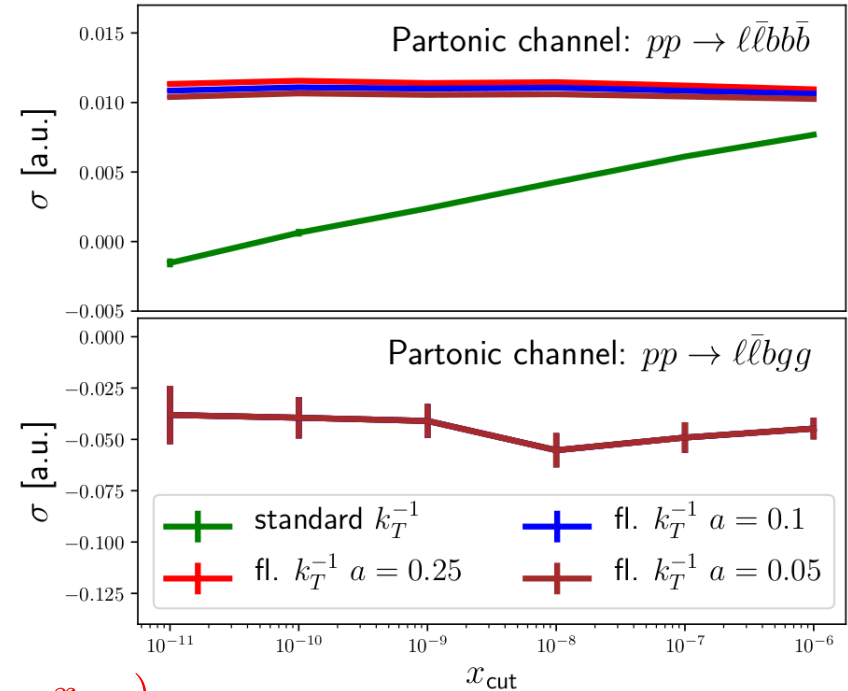

New developments...

Issue for double collinear limits wrt. to initial states

Many thanks to
Caola, Grabarczyk, Hutt, Salam, Scyboz, Thaler



2306.07314

if $y_{12} - y_3 < R$ ☹️

$$\mathcal{S}_{ij} \equiv 1 - \theta(1 - \kappa_{ij}) \cos\left(\frac{\pi}{2}\kappa_{ij}\right) \quad \text{with} \quad \kappa_{ij} \equiv \frac{1}{a} \frac{k_{T,i}^2 + k_{T,j}^2}{2k_{T,\text{max}}^2}$$

Their proposal: $\mathcal{S}_{ij} \rightarrow \bar{\mathcal{S}}_{ij} = \mathcal{S}_{ij} \frac{\Omega_{ij}^2}{\Delta R_{ij}^2}$ $\Omega_{ik}^2 \equiv 2 \left[\frac{1}{\omega^2} (\cosh(\omega \Delta y_{ik}) - 1) - (\cos \Delta \phi_{ik} - 1) \right]$

Flavour anti-kT: impact of Ω_{ij}

Calculations performed with sector-improved residue subtraction scheme

1408.2500 & 1907.12911

Les Houches Jet Flavour WG

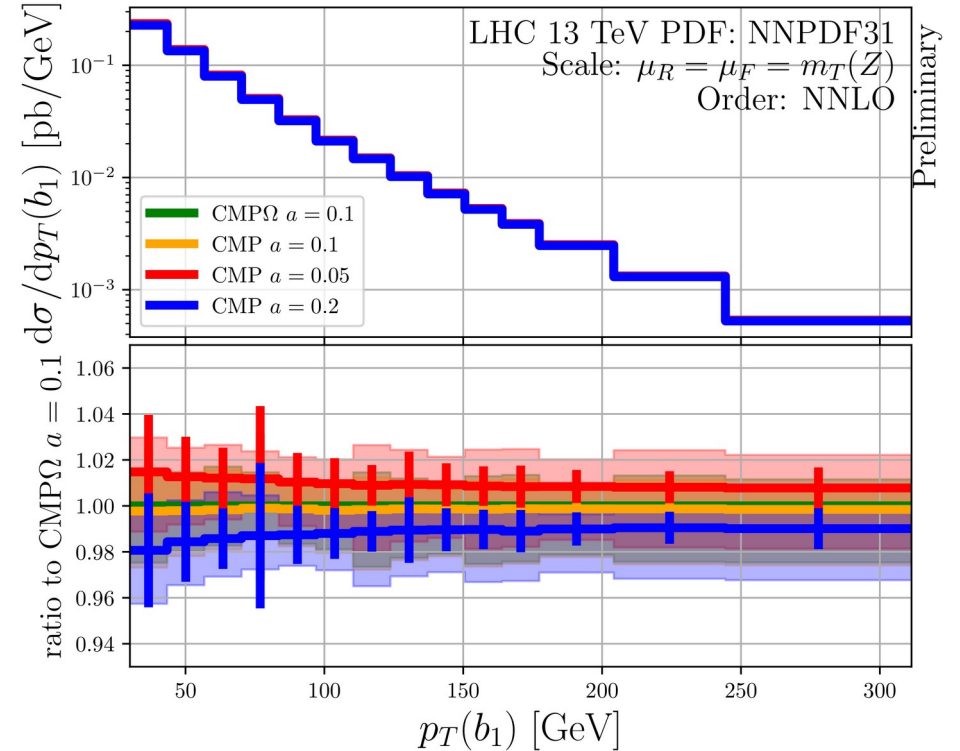
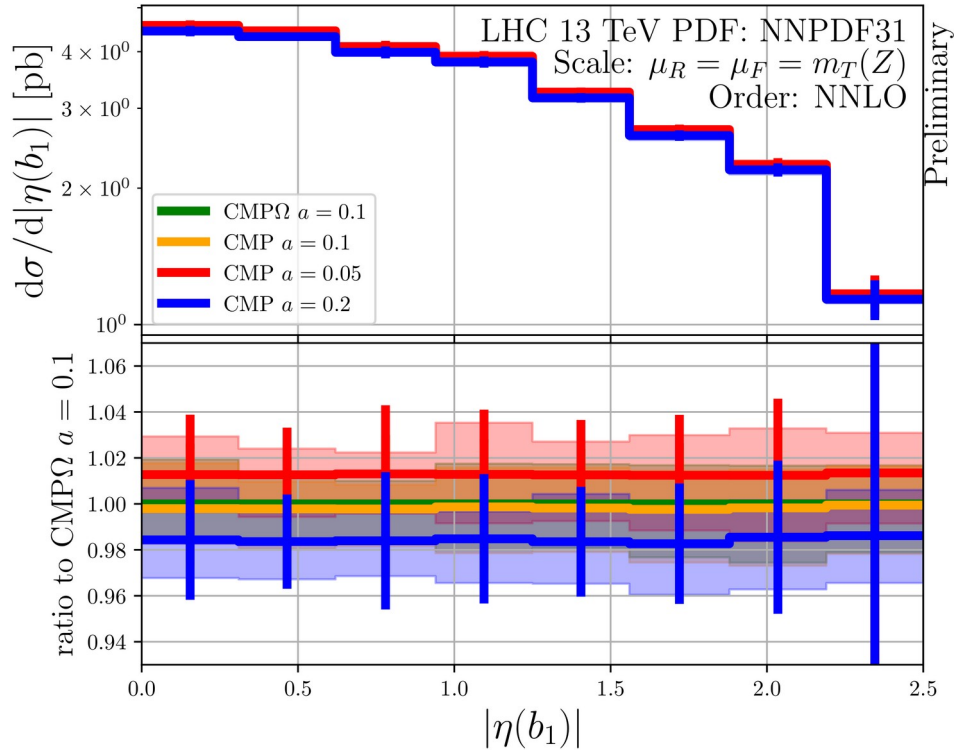

Negligible difference between CMPΩ and CMP

Summary

Take home messages

- 1) NNLO QCD effects in W+charm largely understood.
First comparisons to data → steps towards W+charm in PDF fits
- 2) Flavoured jets require modified jet algorithms to avoid IR safety/sensitivity issues.
Solutions exists for anti-kT jets and are implemented in FastJet: SDF, CMP, GHS, IFN, ...
→ phenomenological applications @ NNLO QCD
- 3) Still open question regarding the best way of comparing state-of-the-art predictions and measurements with flavoured jets:
→ Unfolding? How do the different algorithms compare?
→ Which flavoured jet algorithm has the most favourable properties?

Backup

LHC precision computations with flavoured jets

Associated Higgs production + decays in b-quarks:

Associated production of a Higgs boson decaying into bottom quarks at the LHC in full NNLO QCD

Ferrera, Somogyi, Tramontano 1705.10304

NNLO QCD corrections to associated WH production and $H \rightarrow b\bar{b}$ decay

Caola, Luisoni, Melnikov, Röntsch 1712.06954

Associated production of a Higgs boson decaying into bottom quarks and a weak vector boson decaying leptonically at NNLO in QCD

Gauld, Gehrmann-De Ridder, Glover, Huss, Majer 1907.05836

Bottom quark mass effects in associated WH production with the $H \rightarrow b\bar{b}$ decay through NNLO QCD

Behring, Bizoń, Caola, Melnikov, Röntsch 2003.08321

VH + jet production in hadron-hadron collisions up to order α_s^3 in perturbative QCD

Gauld, Gehrmann-De Ridder, Glover, Huss, Majer 2110.12992

+Partonshower:

NNLOPS accurate associated HZ production with $H \rightarrow b\bar{b}$ decay at NLO

Astill, Bizoń, Re, Zanderighi 1804.08141

NNLOPS description of the $H \rightarrow b\bar{b}$ decay with MiNLO

Bizoń, Re, Zanderighi 1912.09982

Next-to-next-to-leading order event generation for VH production with $H \rightarrow b\bar{b}$ decay

Zanoli, Chiesa, Re, Wiesemann, Zanderighi 2112.04168

LHC precision computations with flavoured jets

Vector + flavoured jet(s) production:

NLO QCD predictions for $Wb\bar{b}$ production in association with up to three light jets at the LHC

Anger, Cordero, Ita, Sotnikov 1712.05721

Predictions for Z-Boson Production in Association with a b-jet at $O(\alpha_s^3)$

Gauld, Gehrmann-De Ridder, Glover, Huss, Majer 2005.03016

NNLO QCD predictions for $W+c$ -jet production at the LHC,

Czakov, Mitov, Pellen, Poncelet 2011.01011

NNLO QCD corrections to $Wb\bar{b}$ production at the LHC,

Hartanto, Poncelet, Popescu, Zoia 2205.01687

A detailed investigation of $W+c$ -jet at the LHC,

Czakov, Mitov, Pellen, Poncelet 2212.00467

Associated production of a W boson and massive bottom quarks at next-to-next-to-leading order in QCD,

Buonocore, Devoto, Kallweit, Mazzitelli, Rottoli, Savoini, 2212.04954

NNLO QCD predictions for Z-boson production in association with a charm jet within the LHCb fiducial region

Gauld, Gehrmann-De Ridder, Glover, Huss, Rodriguez Garcia, Stagnitto 2302.12844

Precise QCD predictions for W-boson production in association with a charm jets

Gehrmann-De Ridder, Gehrmann, Glover, Huss, Garcia, Stagnitto, 2311.14991

Benchmark process: Z+b-jet

Well studied up to $\mathcal{O}(\alpha_s^3)$:

Predictions for Z-Boson Production in Association with a b-jet at $\mathcal{O}(\alpha_s^3)$,
 Gauld, Gehrmann-De Ridder, Glover, Huss, Majer 2005.03016

- Flavour-kT algorithm
- Unfolding of experimental data (RooUnfold, bin-by-bin unfolding)
- Matching between four- and five-flavour schemes (FONLL)

$$d\sigma^{\text{FONLL}} = d\sigma^{5\text{fs}} + (d\sigma_{m_b}^{4\text{fs}} - d\sigma_{m_b \rightarrow 0}^{4\text{fs}})$$

- CMS measurement @ 8 TeV

Measurements of the associated production of a Z boson and b jets in pp collisions at $\sqrt{s} = 8 \text{ TeV}$, CMS 1611.06507

→ Ideal testing ground for flavour anti-kT

$pp \rightarrow Z(\text{ll}) + \text{b-jet}$

5fs:

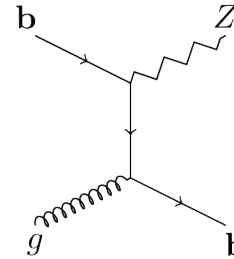

4fs:

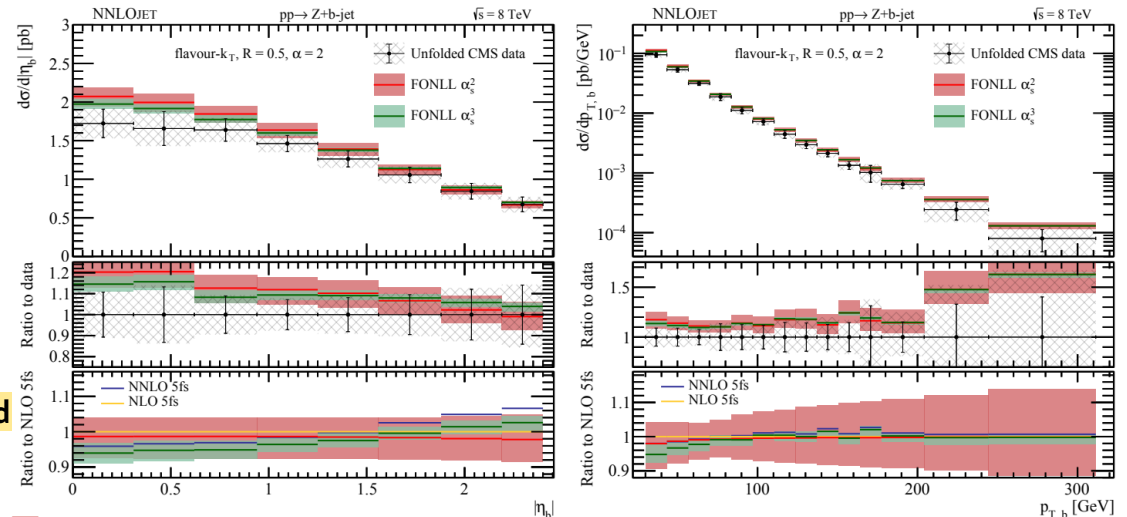
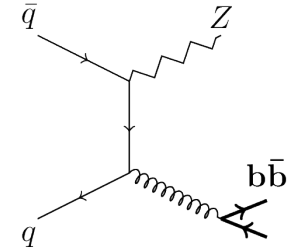

Bin-by-bin unfolding

Estimation of hadronisation and experimental tagging corrections
→ NLO + PS (Madraph+Pythia8)

Unfolding factor = NLO+PS (had = Off) / NLO+PS (had = On)

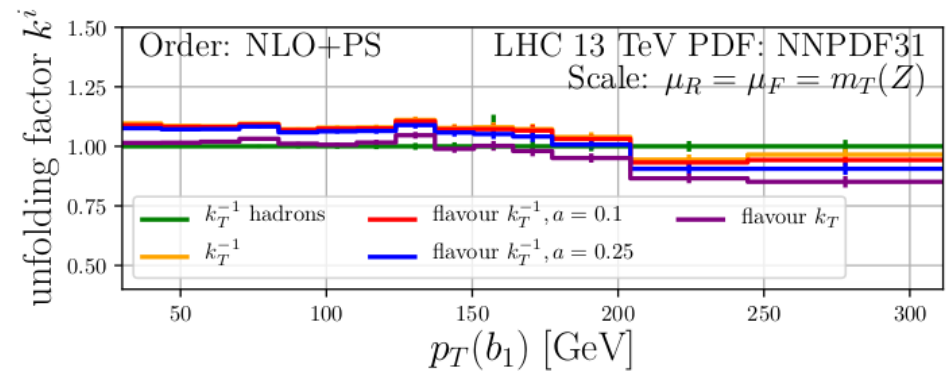
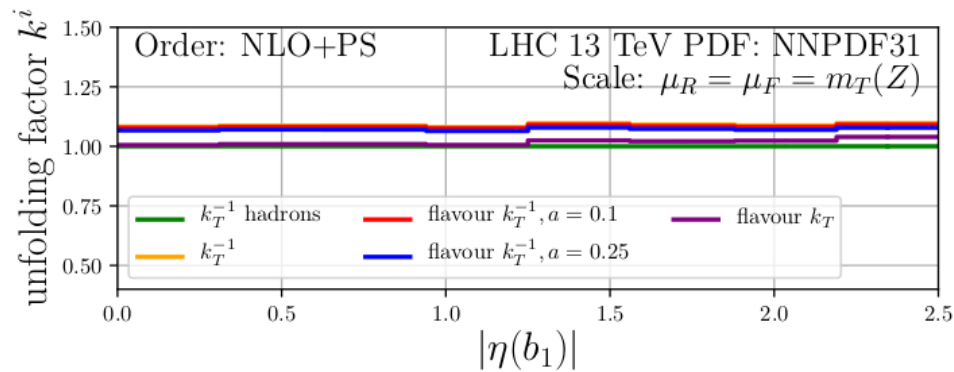

Z+b-jet Phenomenology: Tunable parameter

Benchmark process: $pp \rightarrow Z(\ell\ell) + b\text{-jet}$

Tunable parameter a :

- Limit $a \rightarrow 0 \Leftrightarrow$ original anti-kT (IR unsafe)
- Large $a \Leftrightarrow$ large modification of cluster sequence

Flavour anti-kT ($a=0.01$):

Flavour anti-kT ($a=0.1$):

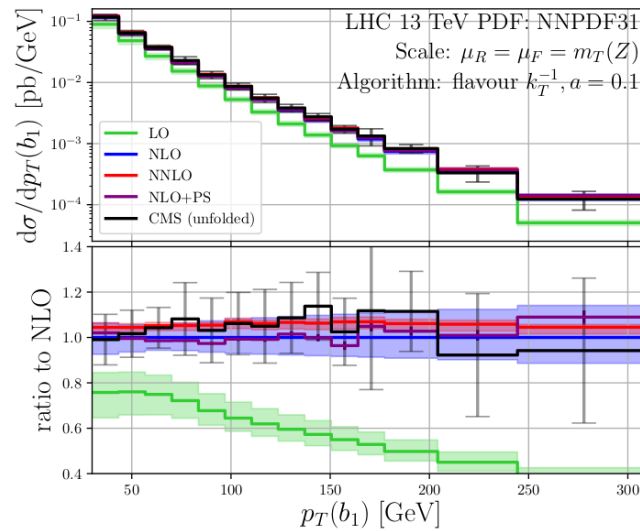
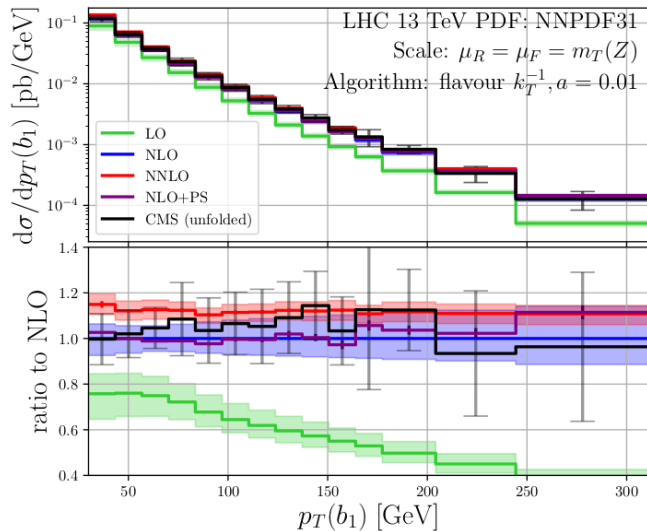

Comparison of different parameter a to data:

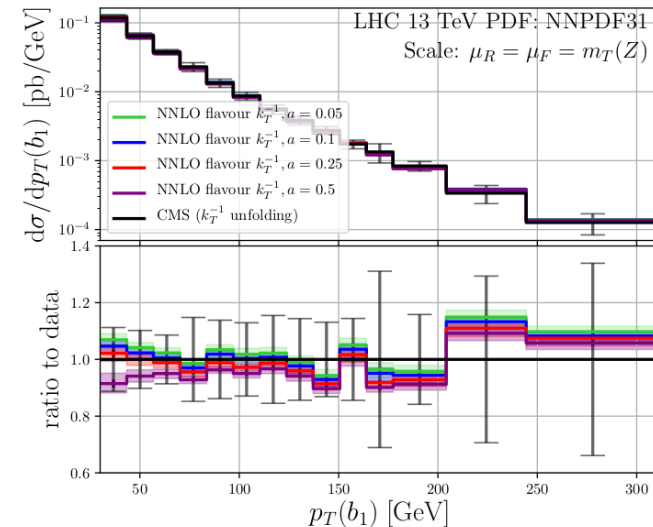

Z+b-jet Phenomenology: Tunable parameter II

What happens in the presence of many flavoured partons? → NLO PS

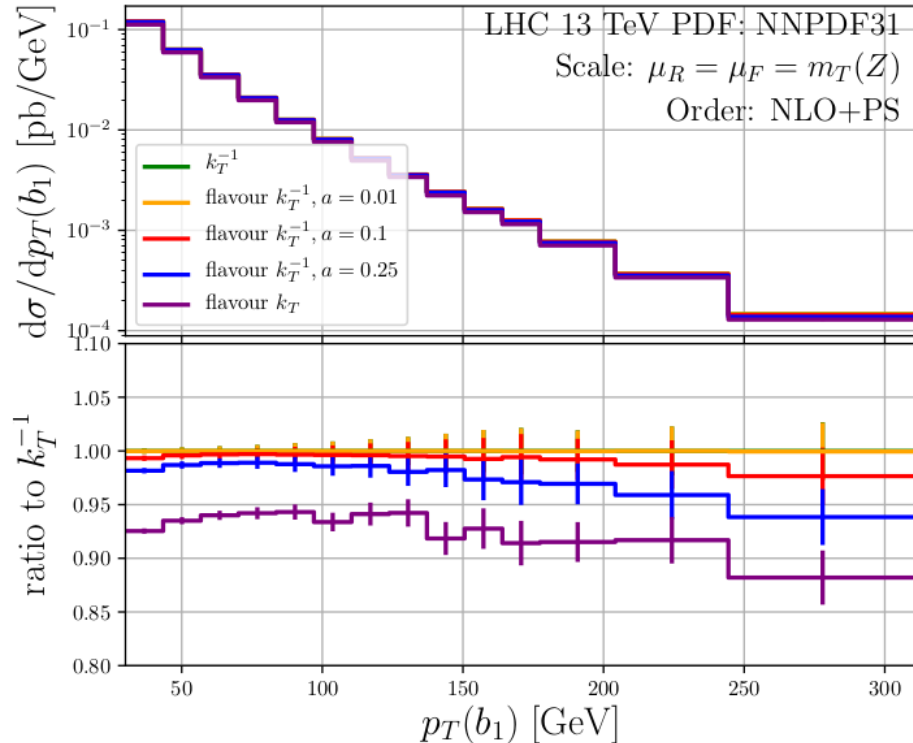

Tunable parameter a:

- Small a: Flavour anti-kT results are more similar to standard anti-kT
- Larger a: Larger modification of clustering

Good FO perturbative convergence +
Small difference to standard anti-kT
→ $a \sim 0.1$ is a good candidate

Tests of IR safety

- Rate of bad-identified jet-flavour as a function of IR sensitive variable
- Parton-shower to model many emissions

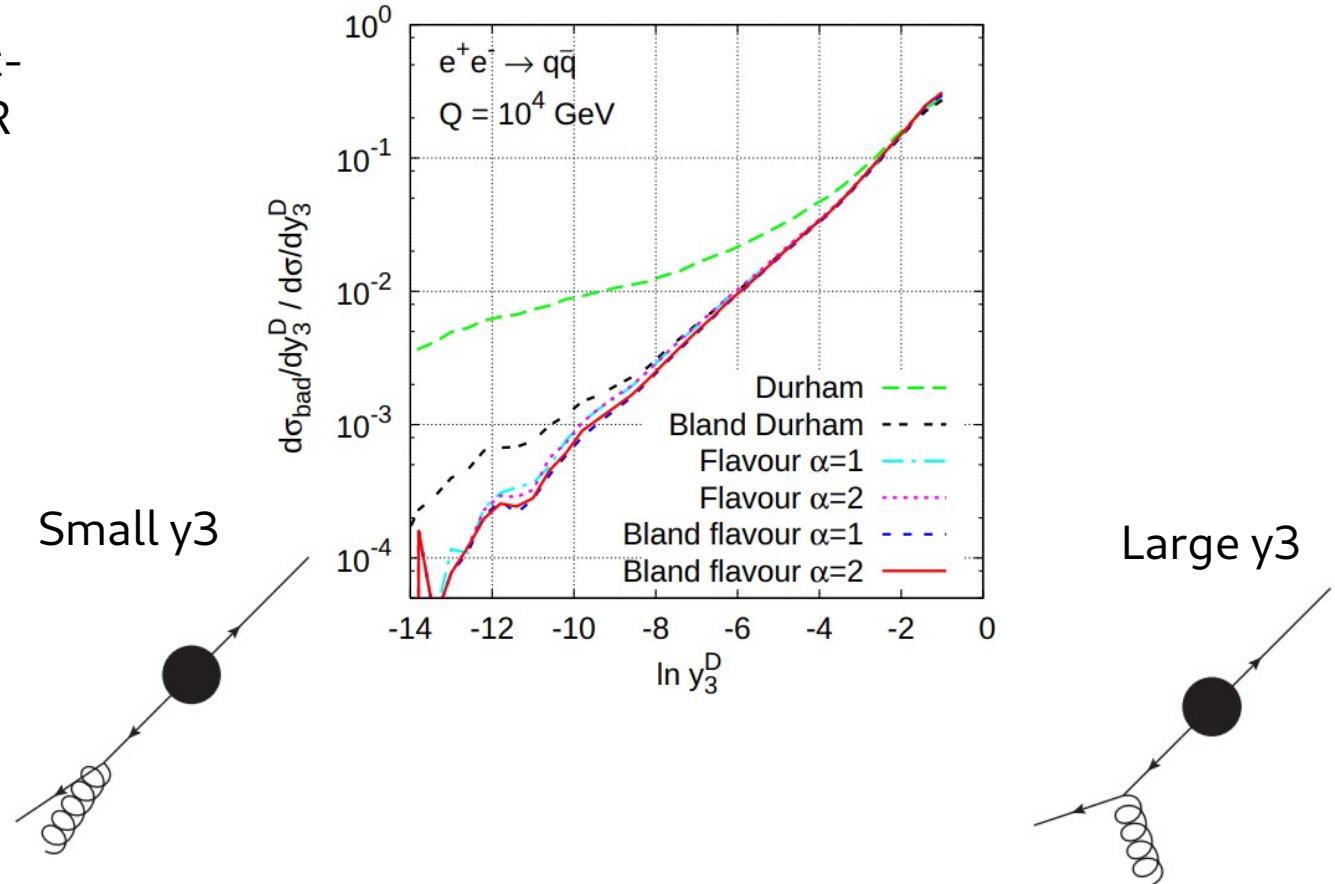

Tests of IR safety with parton showers

- In the di-jet limit the flavour needs to correspond to tree level flavours
- misidentification rate needs to vanish in di-jet back-to-back limit
- IR sensitive observable 2-jettiness

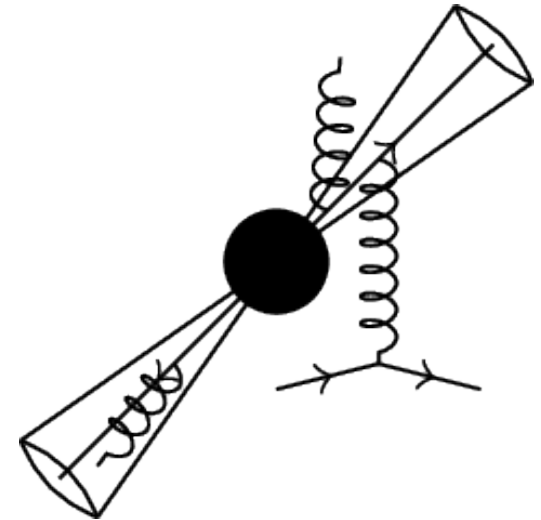
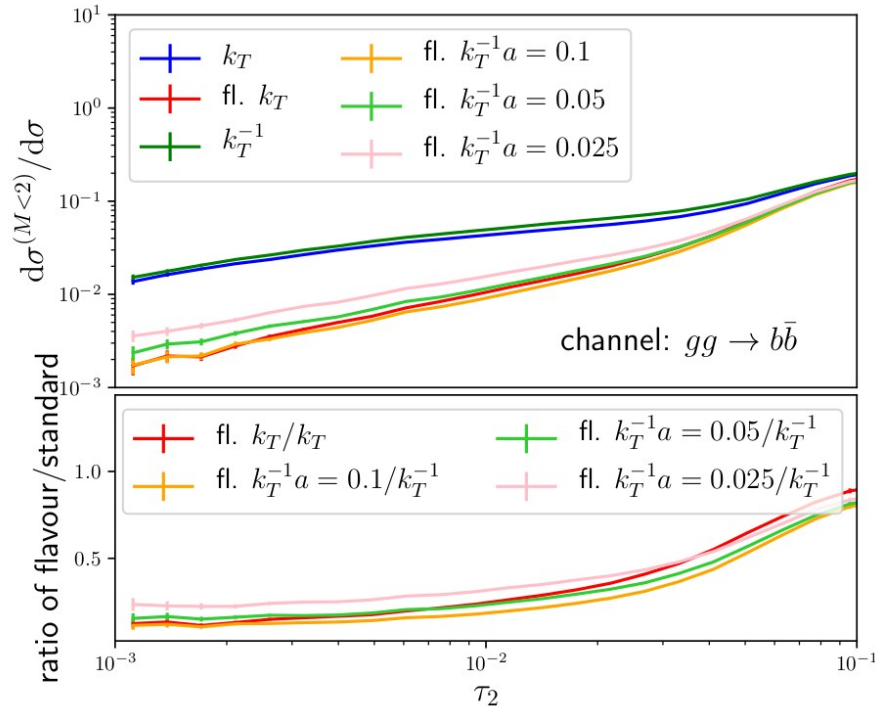

Tests of IR safety with NNLO FO computations

IR sensitivity of jet cross sections on (technical)
IR regulating parameter x

In the limit $x_{\text{cut}} \rightarrow 0$:

IR safe jet flavour \rightarrow no dependence on x_{cut}

IR non-safe jet flavour \rightarrow logarithmic divergent

$$d\sigma \ni d\Phi_{n+2} \left(\text{Diagram 1} \right) F_{n+2} + \dots + d\tilde{\Phi}_{n+2} \mathcal{S}_2 \left(\text{Diagram 2} \right) F_n \theta(x - x_{\text{cut}})$$

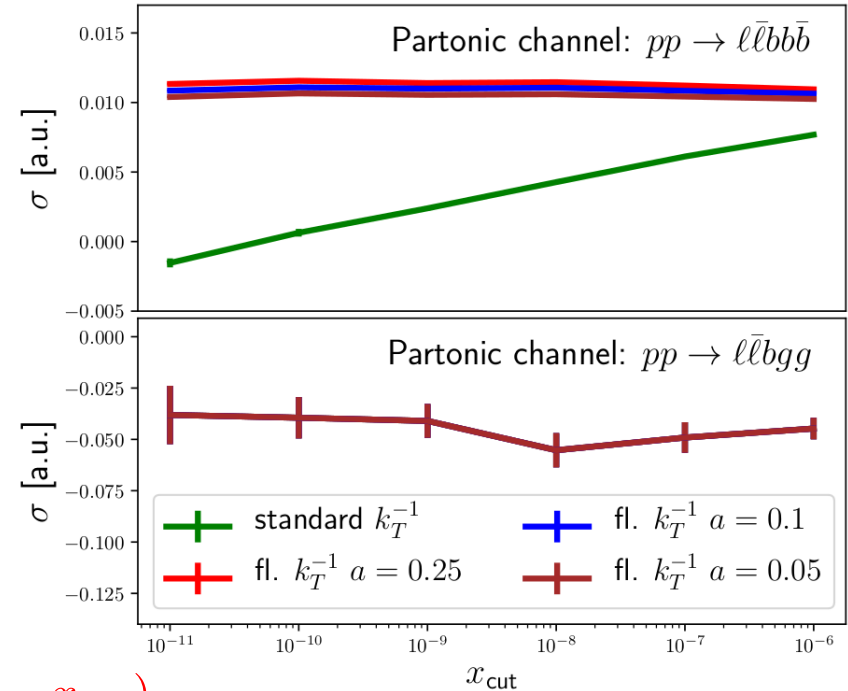

New developments...

Issue for double collinear limits wrt. to initial states

Many thanks to
Caola, Grabarczyk, Hutt, Salam, Scyboz, Thaler



2306.07314

if $y_{12} - y_3 < R$ ☹️

$$\mathcal{S}_{ij} \equiv 1 - \theta(1 - \kappa_{ij}) \cos\left(\frac{\pi}{2}\kappa_{ij}\right) \quad \text{with} \quad \kappa_{ij} \equiv \frac{1}{a} \frac{k_{T,i}^2 + k_{T,j}^2}{2k_{T,\text{max}}^2}$$

Their proposal: $\mathcal{S}_{ij} \rightarrow \bar{\mathcal{S}}_{ij} = \mathcal{S}_{ij} \frac{\Omega_{ij}^2}{\Delta R_{ij}^2}$ $\Omega_{ik}^2 \equiv 2 \left[\frac{1}{\omega^2} (\cosh(\omega \Delta y_{ik}) - 1) - (\cos \Delta \phi_{ik} - 1) \right]$

Flavour anti-kT: impact of Ω_{ij}

Calculations performed with sector-improved residue subtraction scheme

1408.2500 & 1907.12911

Les Houches Jet Flavour WG

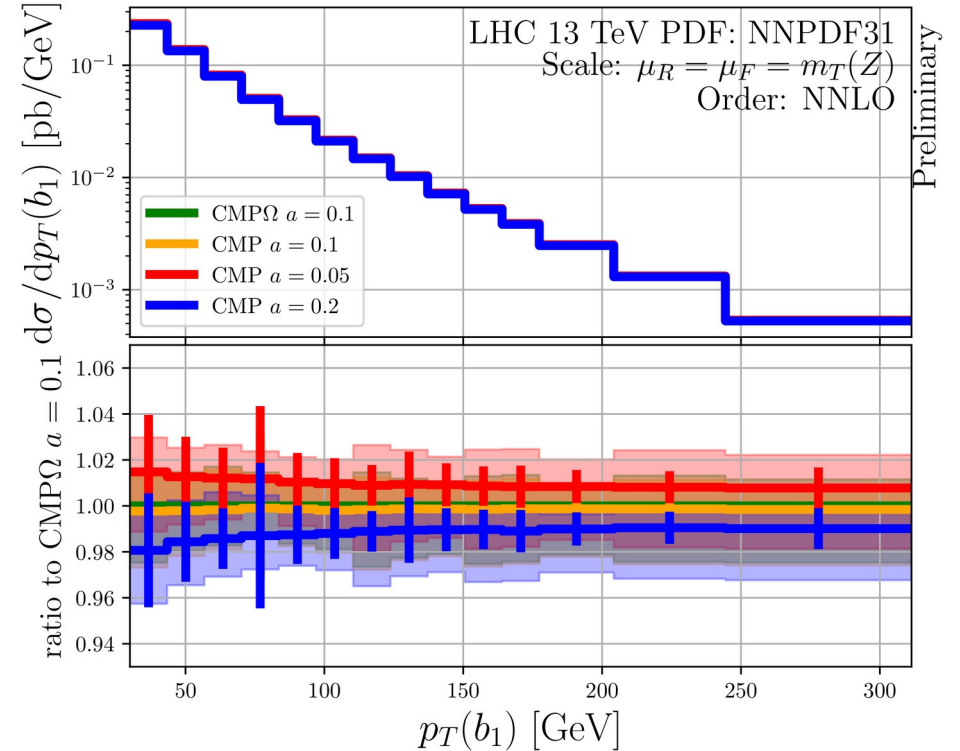
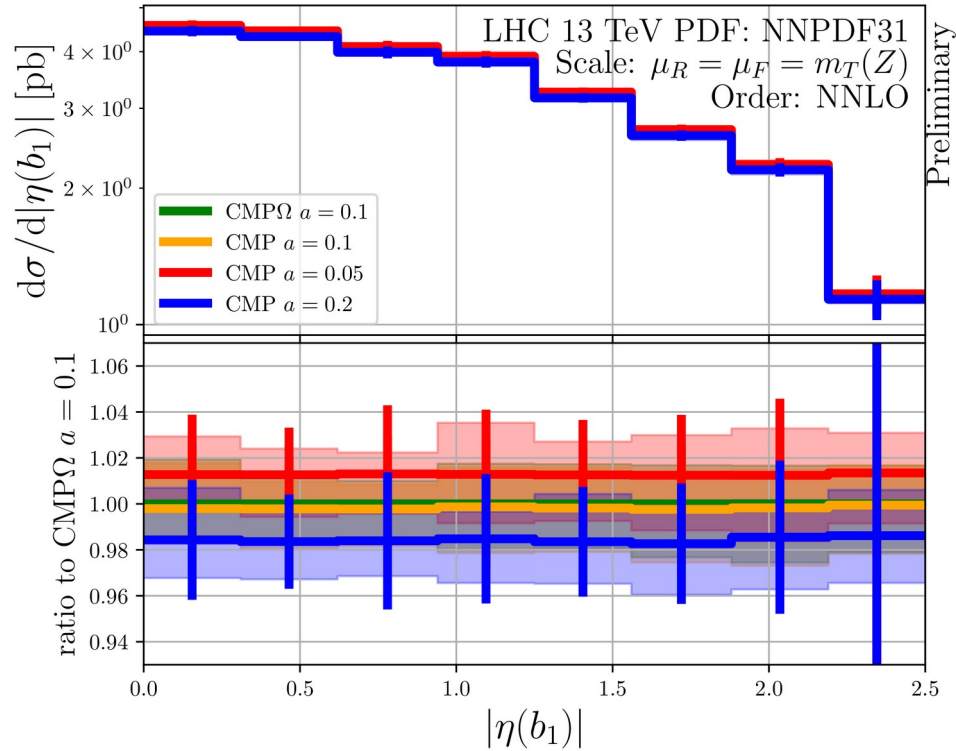

Negligible difference between $\text{CMP}\Omega$ and CMP

W + bottom-pairs

W + b - jets

Motivation: → testing perturbative QCD: large NLO QCD corrections, 4FS vs. 5 FS
→ modelling of flavoured jets

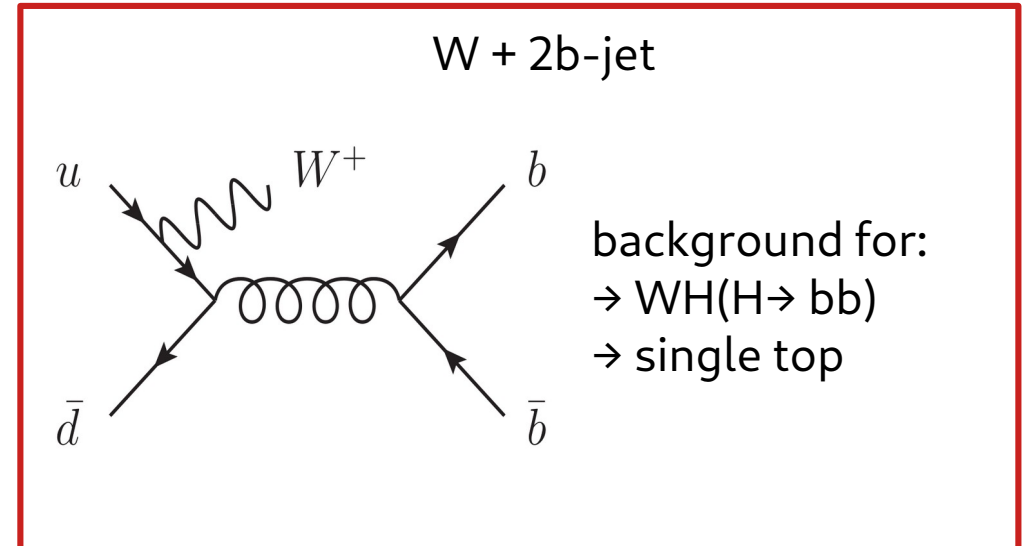
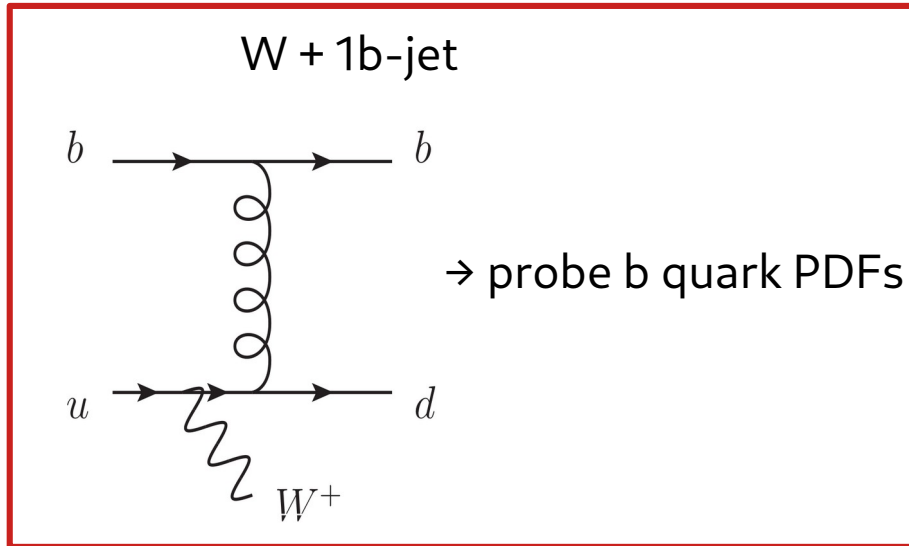

NLO QCD corrections

Experiment: [D0,1210.0627,0410062] [ATLAS,1109.1470,1302.2929][CMS,1312.6608,1608.07561]

Theory W+1 b-jet: [Campbell et al,0611348,0809.3003][Caola et.al.,1107.3714]

Theory W+2 b-jet: mb=0 [Ellis et al,9810489] onshell W: [Cordero et al,0606102] W(lv)bb: [Campbell et al,1011.6647]
 NLO+PS: [Oleari et al,1105.4488][Frederix et al,1110.5502] W(lv)bb: [Luisoni et al,1502.01213]
 W(lv)bb+≤3j: [Anger et al, 1712.05721]

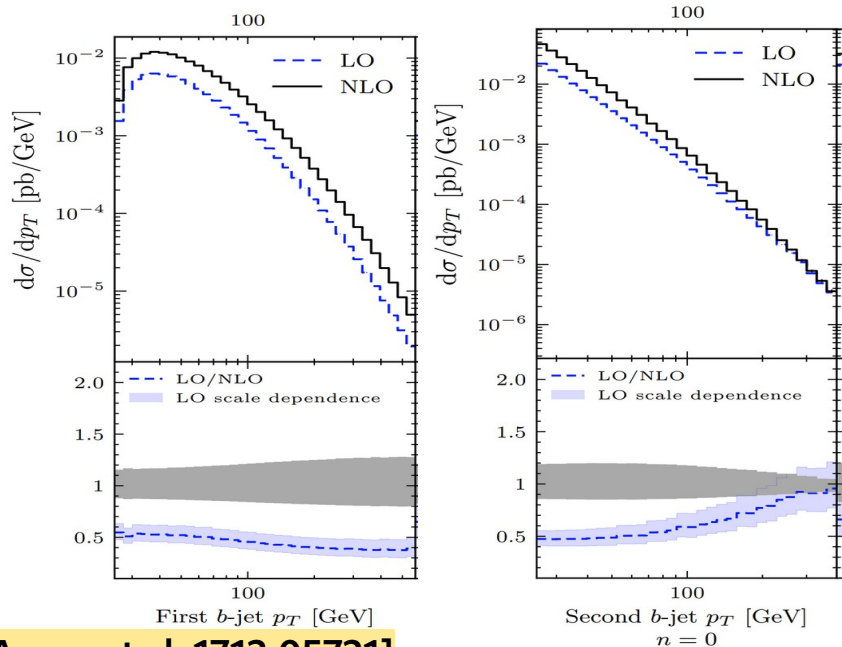

[Anger et al, 1712.05721]



- Large NLO QCD corrections + scale dependence
- Opening of qq-channel



- NNLO QCD corrections required!
- Main challenges:
- **Twoloop amplitudes** [Bager'21,Hartanto'22]
 - **Subtraction** for high-multiplicity processes → Stripper [Czakon'10'14'19]

Setup

NNLO QCD corrections to $Wb\bar{b}$ production at the LHC

Hartanto, Poncelet, Popescu, Zoia 2205.01687

- LHC @ 8 TeV in 5 FS, NNPDF31, scale: $H_T = E_T(l\nu) + p_T(b1) + p_T(b2)$
- Phasespace definition to model **[CMS, 1608.07561]**:
 $p_T(l) \geq 30 \text{ GeV}$ $|y(l)| < 2.1$ $p_T(j) \geq 25 \text{ GeV}$, $|y(j)| < 2.4$
- Inclusive (at least 2 b-jets) and exclusive (exactly 2 b-jets, no other jets) jet phase spaces (defined by the flavour-kT jet algorithm **[Banfi'06]**)

- Inclusive :
 $\sim +20\%$ corrections
 $\sim 7\%$ scale dependence
- Exclusive:
 $\sim +6\%$ corrections
 $\sim 2.5\%$ scale dependence (7-pt)
 Compare decorrelated model: **[Steward'12]**
 $\sim 11\%$ scale dependence

	inclusive [fb]	\mathcal{K}_{inc}	exclusive [fb]	\mathcal{K}_{exc}
σ_{LO}	$213.2(1)^{+21.4\%}_{-16.1\%}$	-	$213.2(1)^{+21.4\%}_{-16.1\%}$	-
σ_{NLO}	$362.0(6)^{+13.7\%}_{-11.4\%}$	1.7	$249.8(4)^{+3.9(+27)\%}_{-6.0(-19)\%}$	1.17
σ_{NNLO}	$445(5)^{+6.7\%}_{-7.0\%}$	1.23	$267(3)^{+1.8(+11)\%}_{-2.5(-11)\%}$	1.067

$$\sigma_{Wb\bar{b},\text{excl.}} = \sigma_{Wb\bar{b},\text{incl.}} - \sigma_{Wb\bar{b}j,\text{incl.}}$$

$$\Delta\sigma_{Wb\bar{b},\text{excl.}} = \sqrt{(\Delta\sigma_{Wb\bar{b},\text{incl.}})^2 + (\Delta\sigma_{Wb\bar{b}j,\text{incl.}})^2}$$

Differential cross sections

Transverse momentum of lepton

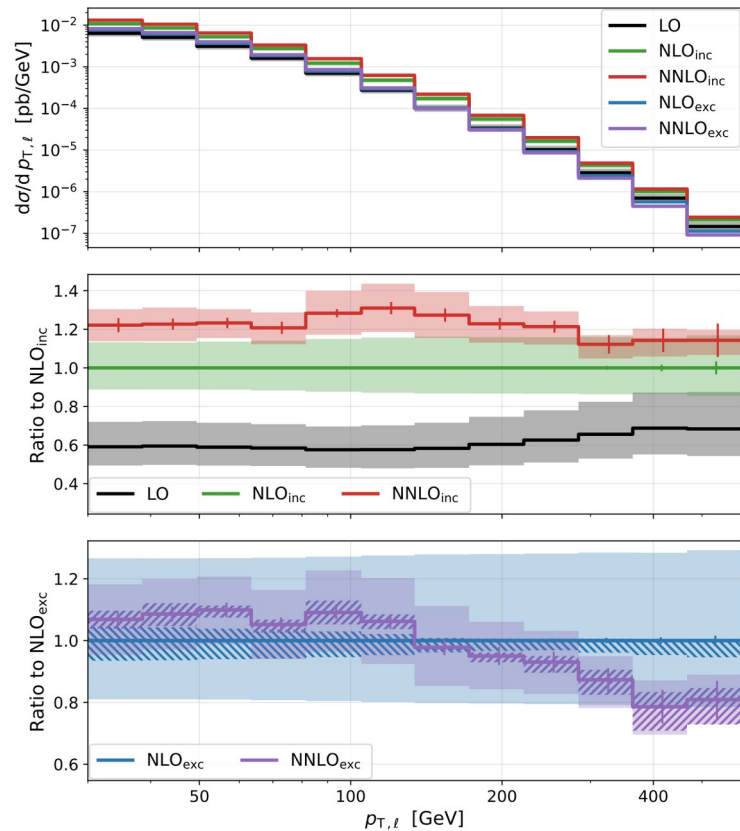

Invariant mass b-jet pair

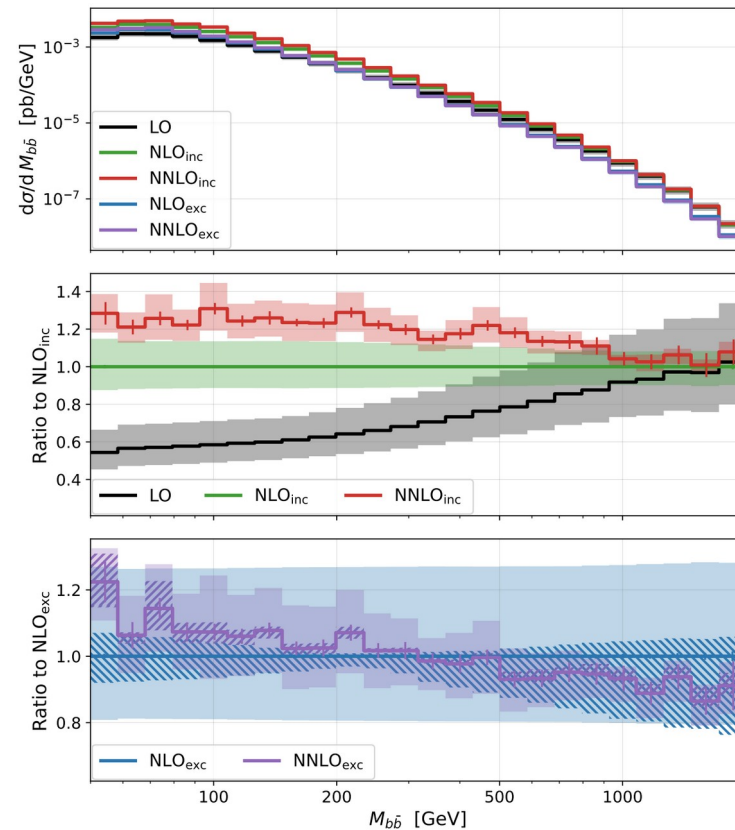

W+2 bjets: flavour anti-kT

Flavour anti-kT algorithm applied to Wbb production at the LHC
Hartanto, Poncelet, Popescu, Zoia 2209.03280

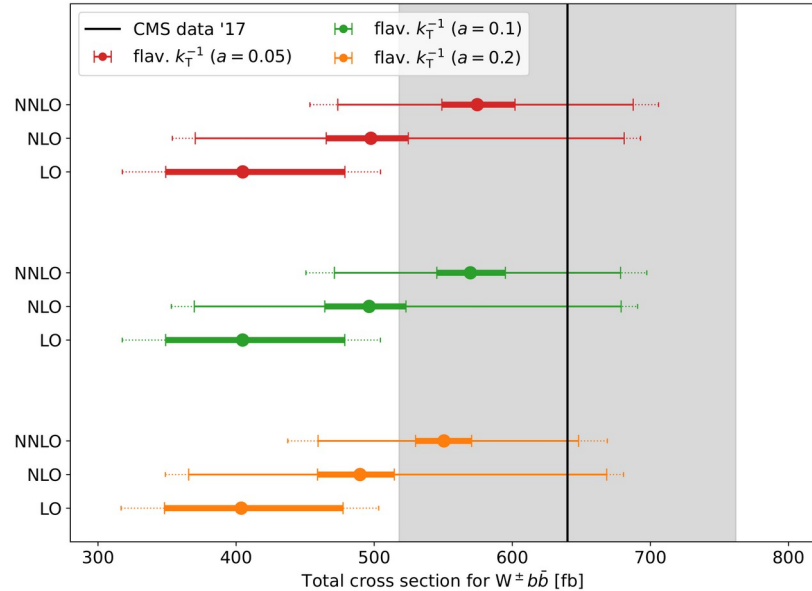

Comparison to data

Measurement of the production cross section of a W boson in association with two b jets in pp collisions at $\sqrt{s} = 8$ TeV, CMS 1608.07561

(assumes small unfolding corrections → wip)

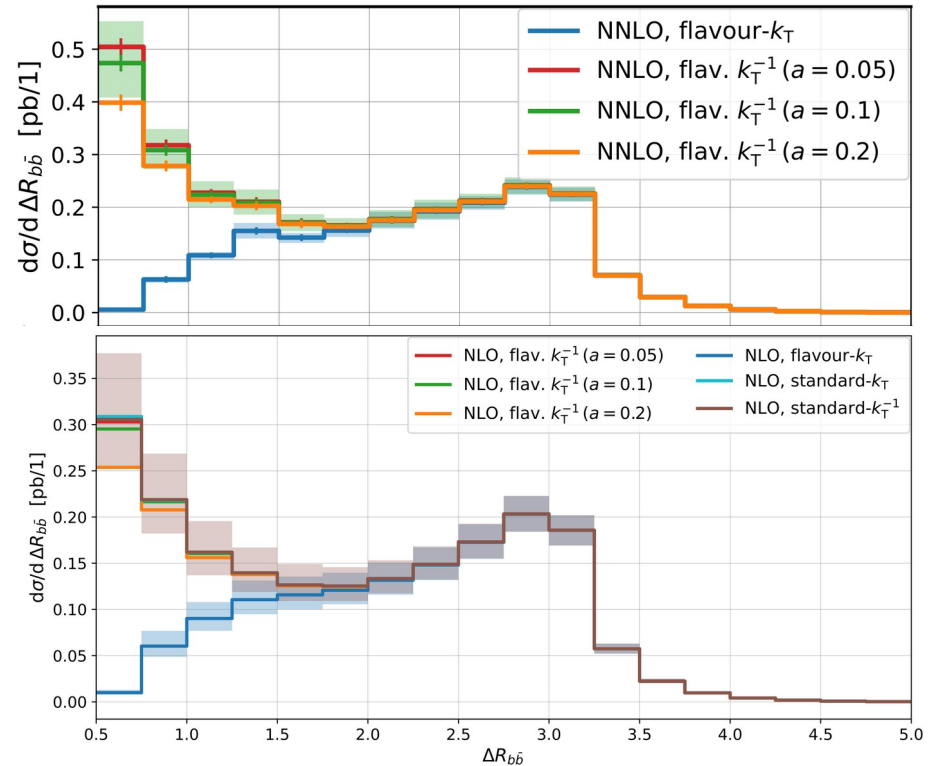

Significant differences between kT and anti-kT
In small DeltaR(bb) region? Beam-function?!

Computation in 4FS

Associated production of a W boson and massive bottom quarks at next-to-next-to-leading order in QCD, Buonocore, Devoto, Kallweit, Mazzitelli, Rottoli, Savoini, 2212.04954

Credit: Luca Buonocore RadCor23

	2209.03280	2212.04954
α_s and PDF scheme	5FS	4FS
Jet clustering algorithm	flavour k_T and flavour anti- k_T algorithm (R=0.5)	k_T and anti- k_T algorithm (R=0.5)
pdf sets	NNPDF31_as_0118 (LO, NLO, NNLO)	NNPDF30_as_0118_nf_4 (LO) NNPDF31_as_0118_nf_4 (NLO, NNLO)

Simplification of massive 2-loop amplitude (Massification) [Mitov, Moch '07]:

$$|\mathcal{M}^{[p],(m)}\rangle = \prod_i \left[Z_{[i]} \left(\frac{m^2}{\mu^2}, \alpha_s(\mu^2), \epsilon \right) \right]^{1/2} \times |\mathcal{M}^{[p]}\rangle + \mathcal{O} \left(\frac{m^2}{Q^2} \right)$$

Comparison 4FS(+PS) vs 5FS

Associated production of a W boson and massive bottom quarks at next-to-next-to-leading order in QCD,
Buonocore, Devoto, Kallweit, Mazzitelli, Rottoli, Savoini, 2212.04954

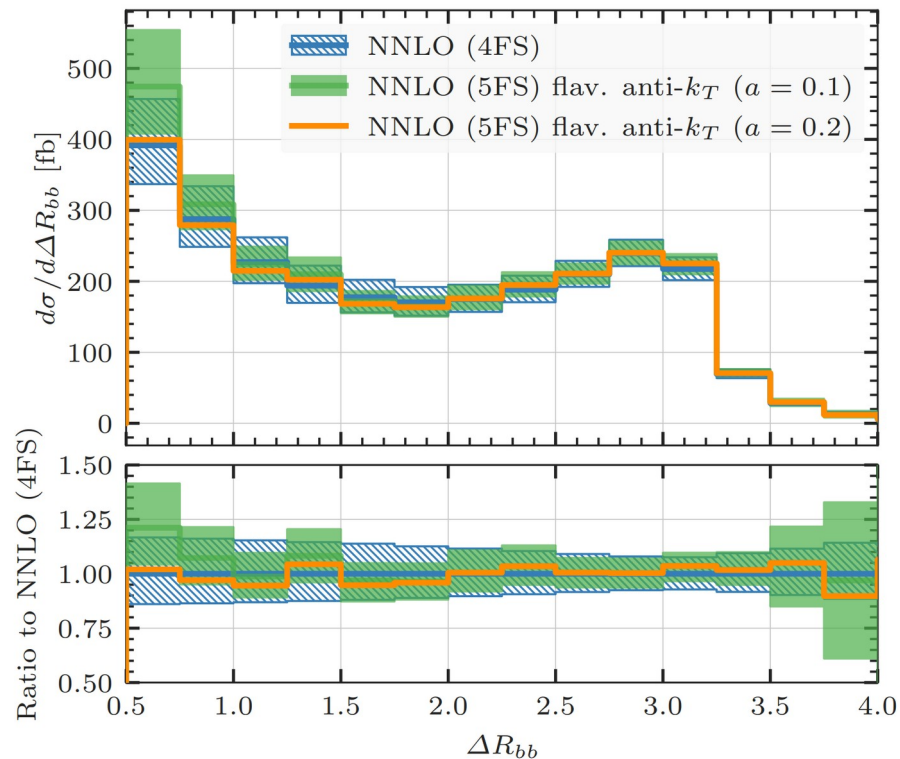
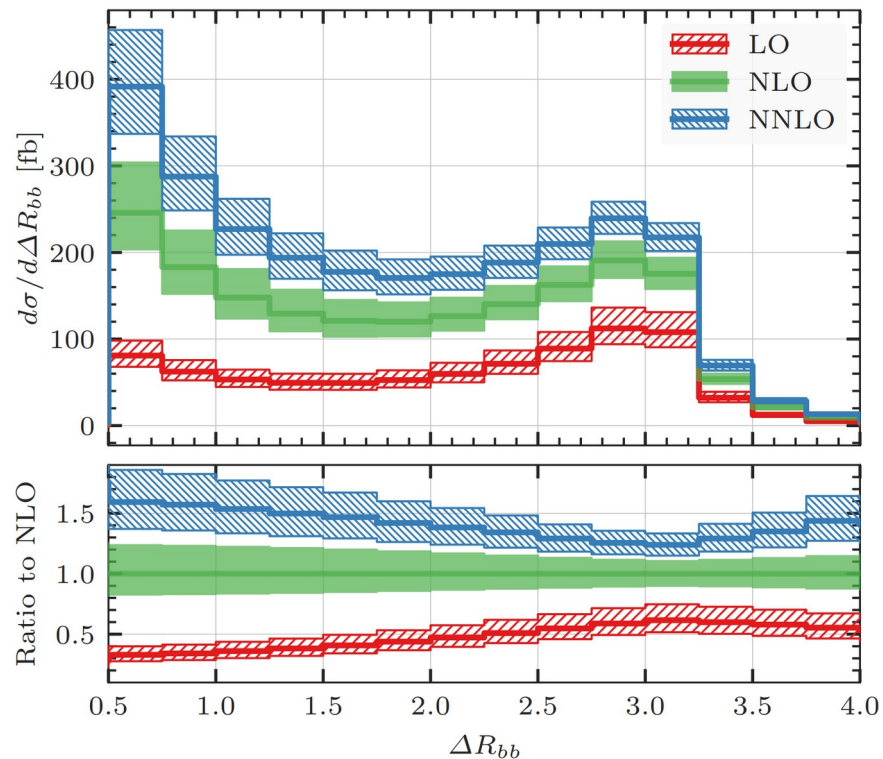

Overview

Old school approach:

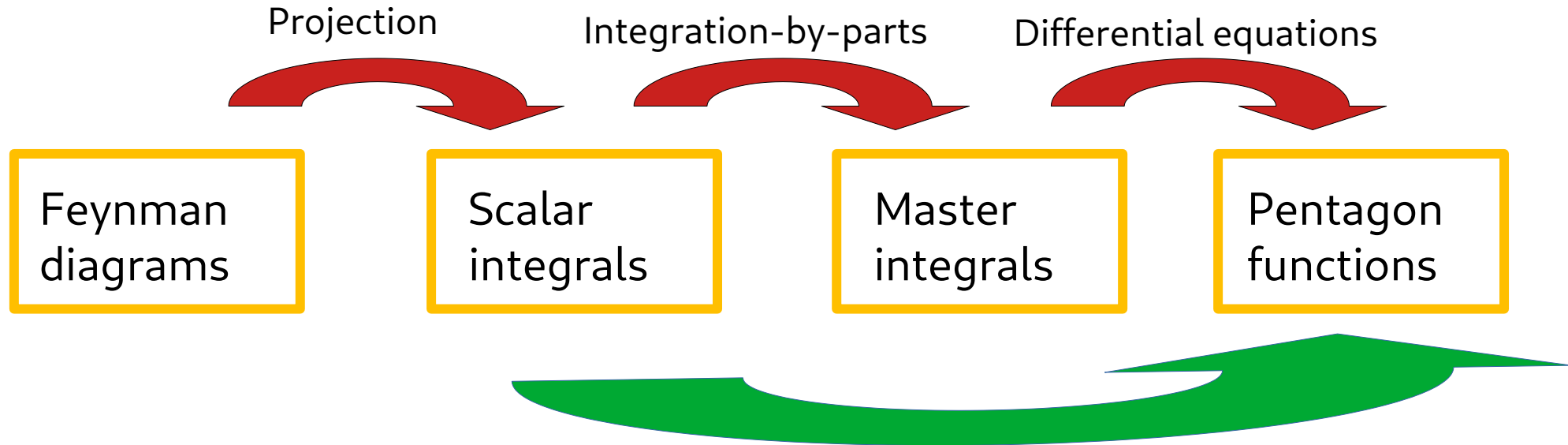

Automated framework using finite fields
to avoid expression swell based on
FiniteFlow [Peraro'19]

Projection to scalar integrals

Generate diagrams (contributing to leading-colour) with QGRAF

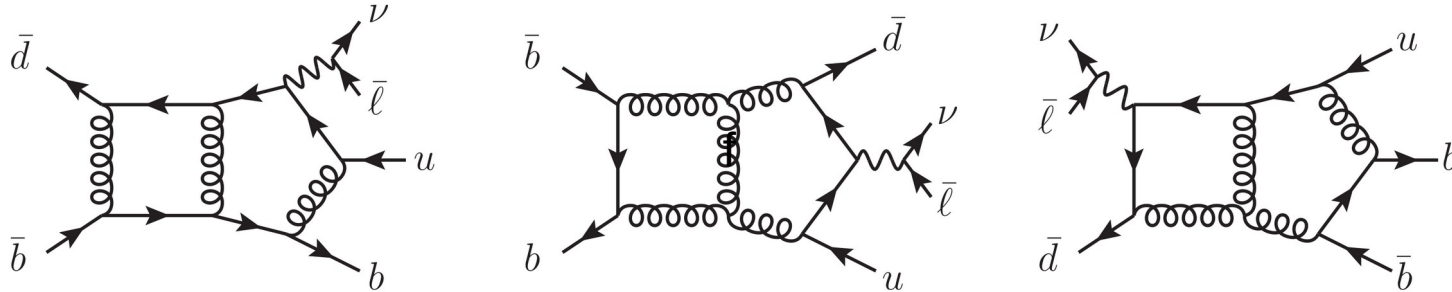

Factorizing decay: $A_6^{(L)} = A_5^{(L)\mu} D_\mu P$ $M_6^{2(L)} = \sum_{\text{spin}} A_6^{(0)*} A_6^{(L)} = M^{(L)\mu\nu} D_{\mu\nu} |P|^2$

Projection on scalar functions (FORM+Mathematica):
 → anti-commuting γ_5 + Larin prescription

$$M_5^{(L)} = \sum_{i=1}^{16} a_i^{(L)} v_i^{\mu\nu}$$

➔
 $a_i^{(L)} = a_i^{(L),\text{even}} + \text{tr}_5 a_i^{(L),\text{odd}}$
 $a_i^{(L),p} = \sum_j c_{j,i}(\{p\}, \epsilon) \mathcal{I}(\{p\}, \epsilon)$

Integration-By-Parts reduction

$$a_i^{(L),p} = \sum_i c_{j,i}(\{p\}, \epsilon) \mathcal{I}(\{p\}, \epsilon)$$

Prohibitively large number of integrals

$$\mathcal{I}_i(\{p\}, \epsilon) \equiv \mathcal{I}(\vec{n}_i, \{p\}, \epsilon) = \int \frac{d^d k_1}{(2\pi)^d} \frac{d^d k_2}{(2\pi)^d} \prod_{k=1}^{11} D_k^{-n_{i,k}}(\{p\}, \{k\})$$

Integration-By-Parts identities connect different integrals \rightarrow system of equations
 \rightarrow only a small number of independent "master" integrals

$$0 = \int \frac{d^d k_1}{(2\pi)^d} \frac{d^d k_2}{(2\pi)^d} l^\mu \frac{\partial}{\partial l^\mu} \prod_{k=1}^{11} D_k^{-n_{i,k}}(\{p\}, \{k\}) \quad \text{with } l \in \{p\} \cap \{k\}$$

LiteRed (+ Finite Fields)



$$a_i^{(L),p} = \sum_i d_{j,i}(\{p\}, \epsilon) \text{MI}(\{p\}, \epsilon)$$

Master integrals & finite remainder

Differential Equations: $d\vec{M}I = dA(\{p\}, \epsilon)\vec{M}I$

[Remiddi, 97]

[Gehrmann, Remiddi, 99]

[Henn, 13]

Canonical basis: $d\vec{M}I = \epsilon d\tilde{A}(\{p\})\vec{M}I$

Simple iterative solution



$$MI_i = \sum_w \epsilon^w \tilde{M}I_i^w \quad \text{with} \quad \tilde{M}I_i^w = \sum_j c_{i,j} m_j$$

Chen-iterated integrals
"Pentagon"-functions

[Chicherin, Sotnikov, 20]

[Chicherin, Sotnikov, Zoia, 21]

Putting everything together (and removing of IR poles):

$$f_i^{(L),p} = a_i^{(L),p} - \text{poles}$$

$$f_i^{(L),p} = \sum_j c_{i,j}(\{p\}) m_j + \mathcal{O}(\epsilon)$$